



EARTHBRAIN



**Smart Construction**  
**3D Machine Guidance**



**Smart Construction**  
**Pilot**

# Tablet APP User Manual

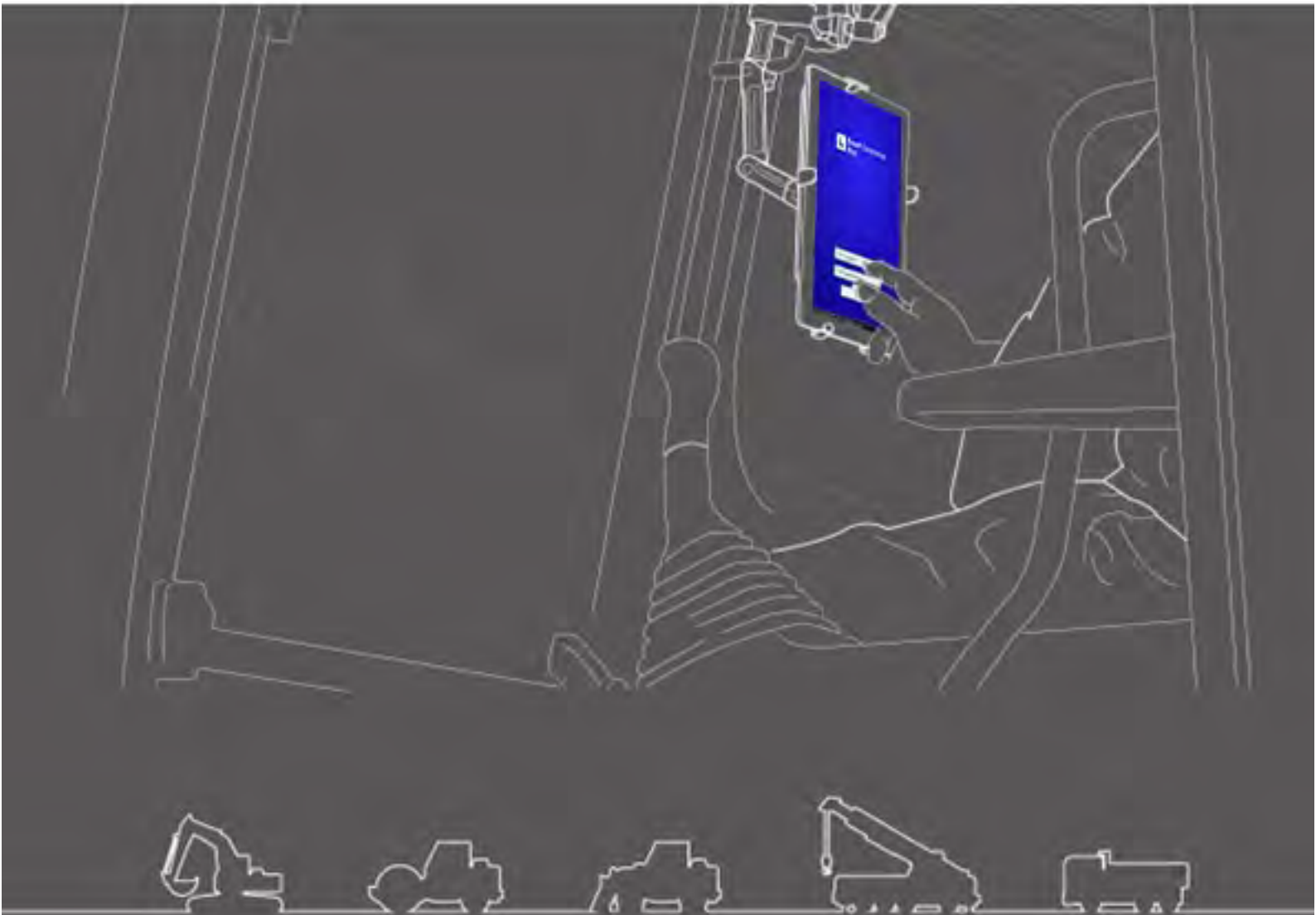

- Be sure to read this document before using this product.
- Please keep this document in a safe place so as not to lose it.

Jun 2024

LL-1001-00-01-0502



# Revision history

| Date    | Content   | Corresponding version |
|---------|---|-----------------------|
| 2020/06 | 1st ver.  | 1st ver.              |
| 2021/10 | Complete revision (addition of project file creation, etc.)                 | v0.9.54.11            |
| 2022/07 | Contact information changed   |                       |
| 2022/08 | Image resolution improved   |                       |
| 2024/6  | Complete revision (addition of geofence function, simulator function, etc.) | v1.0.07               |

---

---

# Before reading this manual

## ⦿ Introduction

- This manual describes the dedicated devices and functions of the Smart Construction 3D Machine Guidance Kit (hereinafter “Kit”). For the devices and functions not covered by this manual, refer to the Operation & Maintenance Manual for the Kit-equipped machine.
- This manual describes the operations and the inspection and maintenance procedures for the Kit and the instructions to be observed for safe use. Many accidents occur when users work without observing the basic precautions. Read all the information stated in the Kit-equipped machine’s Operation & Maintenance Manual and the Shop Manual as well as the alerts and cautions in this manual before operating, inspecting, or maintaining the Kit-equipped machine, and follow their content. Follow the content of warning and caution. Otherwise, it may lead to serious injury or death.
- We cannot predict all the situations you are in when using the Kit. Therefore, precautions stated in the Kit-equipped machine’s Operation & Maintenance Manual/Shop Manual and this manual do not cover every safety precaution.

If you carry out operations, inspections and maintenance in the situations that are not stated in this manual, take all the preventive measures for safety at your risk.

Never carry out operations or works that are prohibited by the Kit-equipped machine’s Operation & Maintenance Manual/Shop Manual and this manual.

- Do not perform work in the wrong way, including operations, inspection, and maintenance of the Kit-equipped machine. Inappropriate operation may lead to serious injury or death.
- If you transfer the Kit-equipped machine, make sure to transfer this manual, too.
- Be sure to keep this manual in the Operation & Maintenance Manual storage location of the Kit-equipped machine so that the staff can refer to it repeatedly at any time.
- If you have lost or damaged this manual, notify the Support Center of it and arrange a substitute promptly.
- In this manual, we use the International System of Units (SI) to indicate units. The descriptions, values, and illustrations in this manual are based on the information as of the time the manual was prepared.
- Since we constantly improve the Kit, the actual specifications may be different from those described in this manual.
- If you have any questions, please contact the Support Center.
- Application software using Open Source Software (OSS) is loaded on the Kit. To use the application software, you need to agree on the terms of use that is displayed when you first start the application software. Read the terms of use for application software thoroughly. You can view the license information about the application software through the menu screen.
- With regard to the content of terms of contract, warranty, and responsibilities, understand the terms of use for application software, before using the application.
- A screen view or displayed content of the application may change by updating.  
If there is a difference between the content described in this manual and that displayed on the screen of the application, follow the latter.
- For the use of the Kit, the manufacturer and distributor are not responsible for the accuracy of the cutting edge and Payload Meter (optional) or failure of the machine body associated with installation.

---

## ⦿ Purpose of use

- The Kit is designed to be retrofitted to provide ICT functionality to an existing excavator. Being equipped with the Kit allows the use of the following functions, thus enabling a conventional type machine to perform ICT construction.
  - 3D Machine Guidance functions (\*1)
  - Function to acquire 3D construction history data
  - Payload Meter (optional) (\*2)
- \*1 A function to acquire location information of the machine by GNSS, and provide a tablet terminal at the operator seat with the difference between design data of the construction area and location of the bucket cutting edge.
- \*2 A function to measure the weight of soil to be loaded with the bucket of the excavator.

## ⦿ Restrictions on users

- Any worker operating and working on the Kit-equipped machine must have the qualifications required to operate an excavator. For more information, refer to the Operation & Maintenance Manual for the Kit-equipped machine.

## ⦿ Trademarks in this manual

- Smart Construction, Smart Construction 3D Machine Guidance, and Smart Construction Pilot are trademarks or registered trademarks of Komatsu Ltd.
- Wi-Fi is a registered trademark of the Wi-Fi Alliance.
- Android, Google, Google Play, and logo of Google Play are trademarks or registered trademarks of Google LLC.
- docomo is a registered trademark or trademark of NTT DOCOMO, INC.
- iPad is a registered trademark of Apple Inc.
- iOS is an OS name of Apple Inc. IOS is a registered trademark or trademark of Cisco Systems, Inc. or its affiliates in the United States and other countries and is used under license.
- Lenovo is a trademark of Lenovo Corporation.
- Pocket WiFi is a trademark of SoftBank Corporation.
- \* Other names such as company names and product names used in this manual are generally trade names, registered trademarks, or trademarks of respective companies.

---

---

# Contents

|   |           |
|---|-----------|
| <b>1. Safety precautions .....</b>                    | <b>7</b>  |
| 1.1 Meaning of warning labels (signal words).....     | 7         |
| 1.2 Safety precautions.....                           | 7         |
| <b>2. Outline .....</b>                               | <b>8</b>  |
| 2.1 Outline of Kit (bundled items).....               | 8         |
| 2.2 Schematic diagram .....                           | 8         |
| 2.3 What you need to prepare.....                     | 9         |
| 2.3.1 Tablet terminal (compatible tablet types) ..... | 9         |
| 2.3.2 Tablet holder attachment.....                   | 9         |
| 2.3.3 Wi-Fi router .....                              | 10        |
| 2.3.4 Tablet power feeding apparatus.....             | 10        |
| 2.3.5 Local storage device .....                      | 11        |
| <b>3. Before starting work.....</b>                   | <b>12</b> |
| 3.1 Points to note .....                              | 12        |
| 3.2 Workflow.....                                     | 13        |
| 3.3 Equipment look around inspection .....            | 15        |
| 3.3.1 Checking installation of GNSS antenna.....      | 15        |
| 3.3.2 Checking installation of GNSS controller .....  | 15        |
| 3.4 Checking installation.....                        | 16        |
| 3.5 Setting Wi-Fi.....                                | 17        |
| 3.6 Installing application .....                      | 18        |
| 3.7 Starting Smart Construction Pilot.....            | 19        |
| 3.8 Setting common items .....                        | 21        |
| 3.9 Project file.....                                 | 21        |
| 3.9.1 Acquiring project files .....                   | 23        |
| 3.9.2 Creating project files .....                    | 25        |
| 3.9.3 Selecting project files .....                   | 33        |
| 3.9.4 Selecting project display layer .....           | 34        |
| 3.9.5 Editing project files .....                     | 34        |
| 3.10 Checking cutting edge position accuracy .....    | 36        |
| 3.10.1 Preparation for checking .....                 | 36        |
| 3.10.2 Checking GNSS information .....                | 36        |
| 3.10.3 Checking cutting edge position accuracy .....  | 37        |
| <b>4. How to use Smart Construction Pilot.....</b>    | <b>40</b> |
| 4.1 Using 3D Machine Guidance function.....           | 40        |
| 4.1.1 Displaying main screen.....                     | 40        |
| 4.1.2 Main screen operations.....                     | 40        |
| 4.1.3 Guidance view operations.....                   | 44        |
| 4.1.4 Target surface TIN selection view .....         | 46        |
| 4.1.5 Destination setting view .....                  | 46        |
| 4.1.6 Other display items .....                       | 47        |

|            |   |            |
|------------|---|------------|
| <b>4.2</b> | <b>Setting 3D Machine Guidance.....</b>                         | <b>53</b>  |
| 4.2.1      | Measuring cutting edge position .....                           | 54         |
| 4.2.2      | Changing target surface settings .....                          | 55         |
| 4.2.3      | Changing facing angle compass and sound settings .....          | 57         |
| 4.2.4      | Changing heat map and sound settings .....                      | 58         |
| 4.2.5      | Changing application settings .....                             | 59         |
| 4.2.6      | Changing guidance color settings.....                           | 61         |
| <b>5.</b>  | <b>Customization .....</b>                                      | <b>62</b>  |
| <b>5.1</b> | <b>Changing GNSS settings .....</b>                             | <b>62</b>  |
| 5.1.1      | Checking or changing GNSS settings .....                        | 63         |
| 5.1.2      | Changing Ntrip settings.....                                    | 64         |
| 5.1.3      | Checking GNSS information .....                                 | 64         |
| <b>5.2</b> | <b>Changing bucket configuration .....</b>                      | <b>66</b>  |
| 5.2.1      | Downloading bucket file .....                                   | 67         |
| 5.2.2      | Bucket calibration.....   | 68         |
| 5.2.3      | Selecting bucket.....   | 77         |
| 5.2.4      | Calibrating bucket tooth .....                                  | 77         |
| <b>5.3</b> | <b>Changing machine calibration settings.....</b>               | <b>78</b>  |
| 5.3.1      | Performing machine calibration .....                            | 79         |
| 5.3.1.1    | Performing machine calibration for standard specification ..... | 79         |
| 5.3.1.2    | Performing machine calibration for offset specification .....   | 88         |
| 5.3.2      | Checking machine calibration information .....                  | 92         |
| 5.3.3      | Checking position and posture of machine body .....             | 93         |
| 5.3.4      | Swing sensor calibration .....                                  | 93         |
| 5.3.5      | Individual calibration .....                                    | 99         |
| 5.3.6      | 2D/3D accuracy check .....                                      | 104        |
| <b>5.4</b> | <b>Changing calibration settings for extension arm.....</b>     | <b>106</b> |
| 5.4.1      | Selecting extension arm file .....                              | 106        |
| 5.4.2      | Downloading extension arm file .....                            | 107        |
| 5.4.3      | Creating extension arm file .....                               | 107        |
| 5.4.4      | Editing extension arm file .....                                | 113        |
| <b>5.5</b> | <b>Using geofence function .....</b>                            | <b>114</b> |
| 5.5.1      | Enabling function.....  | 114        |
| 5.5.2      | Setting geofence type .....                                     | 114        |
| 5.5.3      | Setting alert type .....  | 118        |
| 5.5.4      | Setting detection area .....                                    | 118        |
| 5.5.5      | Creating geofence.....  | 120        |
| 5.5.6      | Display on guidance screen.....                                 | 124        |
| 5.5.7      | Downloading geofence .....                                      | 125        |
| 5.5.8      | Editing geofence .....  | 127        |
| <b>5.6</b> | <b>Using simulator function.....</b>                            | <b>129</b> |
| 5.6.1      | Switching to simulator mode .....                               | 129        |
| 5.6.2      | Operating simulator screen.....                                 | 129        |
| 5.6.3      | Restrictions in using simulator function.....                   | 131        |
| <b>5.7</b> | <b>Using 2D Machine Guidance.....</b>                           | <b>134</b> |
| 5.7.1      | Enabling 2D Machine Guidance .....                              | 134        |
| 5.7.2      | Setting design surface .....                                    | 134        |
| <b>5.8</b> | <b>Using 3DMG Basic .....</b>                                   | <b>136</b> |
| 5.8.1      | Screen description .....  | 136        |
| 5.8.2      | Setting target surface.....                                     | 137        |
| 5.8.3      | Adjusting target surface .....                                  | 138        |
| 5.8.4      | Adjusting construction width and direction .....                | 139        |

---



|  |            |
|--|------------|
| 5.8.5 Working with guidance screen .....           | 141        |
| <b>5.9 System management .....</b>                 | <b>142</b> |
| 5.9.1 Checking controller information .....        | 143        |
| 5.9.2 Checking/changing network settings .....     | 143        |
| <b>5.10 Administrator settings.....</b>            | <b>145</b> |
| 5.10.1 Checking controller information .....       | 146        |
| 5.10.2 Setting network .....                       | 147        |
| 5.10.3 Changing server settings .....              | 147        |
| 5.10.4 Changing system settings.....               | 148        |
| 5.10.5 Changing machine calibration settings ..... | 149        |
| 5.10.6 Checking product settings.....              | 152        |
| 5.10.7 Setting administrator guidance .....        | 152        |
| <b>6. Payload meter (optional).....</b>            | <b>153</b> |
| <b>6.1 Setting payload meter .....</b>             | <b>153</b> |
| 6.1.1 Basic settings .....                         | 153        |
| 6.1.2 Changing bucket .....                        | 157        |
| <b>6.2 Calibrating payload meter .....</b>         | <b>158</b> |
| 6.2.1 Unloaded calibration .....                   | 158        |
| 6.2.2 Loaded calibration.....                      | 160        |
| <b>6.3 How to use payload meter.....</b>           | <b>163</b> |
| 6.3.1 Display content on payload meter screen..... | 164        |
| 6.3.2 How to operate payload meter screen .....    | 165        |
| 6.3.3 Payload meter functions .....                | 165        |
| 6.3.4 Other payload functions .....                | 167        |
| <b>6.4 Judgment by accuracy check mode .....</b>   | <b>168</b> |
| <b>7. Product specifications .....</b>             | <b>170</b> |
| <b>8. Troubleshooting.....</b>                     | <b>172</b> |
| <b>9. Contact information.....</b>                 | <b>180</b> |



# 1. Safety precautions

## 1.1 Meaning of warning labels (signal words)

The following warning labels are used in this manual and on the Kit to help users identify the message concerning safety. Observe those warning labels.

|  |  |
|--|--|
|  <b>WARNING</b> | The label shows what would lead to serious injury or death if you do not avoid the risk. |
|  <b>CAUTION</b> | The label shows what would lead to serious injury if you do not avoid the risk.          |

The following labels show other precautions which the users must observe to use the Kit and the Kit-equipped machine.

|                                  |  |
|----------------------------------|--|
| <b>Notice</b>                    | This label shows what is important for the proper use of the Kit and Kit-equipped machine. |
| <b>Supplementary explanation</b> | Useful information to know.  |

## 1.2 Safety precautions

|  |
|--|
|  <b>WARNING</b>   |
| <p style="text-align: center;"><b>THERE IS A POSSIBILITY OF SERIOUS INJURY OR DEATH.</b></p> <p>For the safety of workers and their surroundings, be sure to follow all the alerts and preventive measures displayed in this manual and on the Kit-equipped machine.</p> |

# 2. Outline

## 2.1 Outline of Kit (bundled items)

The following are the items bundled with the Kit.

- Bucket IMU
- Arm IMU
- Boom IMU
- Machine body IMU
- GNSS antenna (2 pieces)
- GNSS controller
- Harness
- Pressure sensor (2 pieces) (optional)
- Mounting bracket, etc.

## 2.2 Schematic diagram

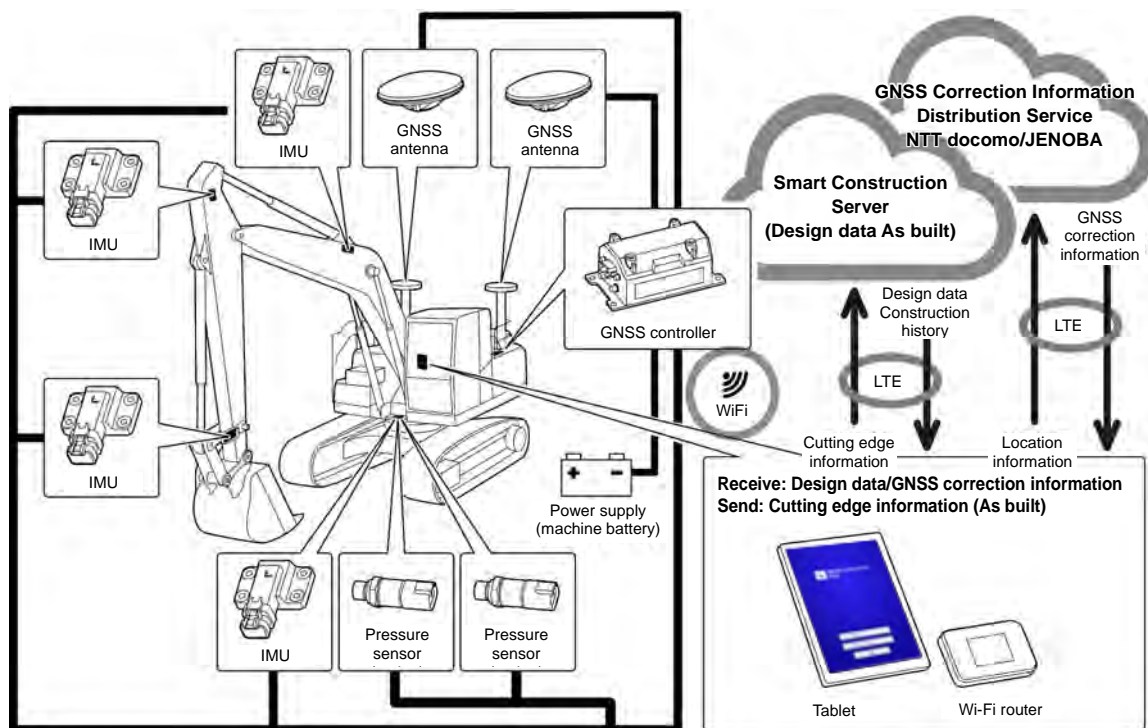

### Notice

- When using with a construction machine of two-piece boom, a 2nd boom IMU sensor needs to be installed.
- When using with a construction machine of swing boom, a swing boom sensor and a link mechanism for swing need to be installed.

---

---

## 2.3 What you need to prepare

After installing the Kit on the machine, the following devices are required to use the ICT functions: tablet terminal, tablet power feeding apparatus, tablet holder attachment, and Wi-Fi router. Please prepare those devices, because they are not bundled with the Kit.

### 2.3.1 Tablet terminal (compatible tablet types)

---

After installing the Kit, you can use ICT functions through operating the tablet terminal on which the application software is installed.

The following tablet terminals have been confirmed to work properly:

- Lenovo Tab M10 HD (2nd Gen) (OS:Android11)
- Lenovo M10 Plus (3rd Gen) (OS:Android12)
- Lenovo P11 Pro (2nd Gen) (OS:Android12)

For other terminals, contact the Support Center.

\* You cannot use iOS terminals, such as iPad.

#### Supplementary explanation

- If you update the OS, the version is changed to the latest one as of the time of update. After the update, it cannot be restored to the old version. Please note that, after updating the software to the latest version, operation of the tablet terminal may slow down or the tablet terminal may not operate because it is not compatible with the latest version, depending on the time the tablet terminal you prepared is produced.
- In rare cases, the internal data of the tablet terminal may be damaged or deleted, or the terminal may become unbootable after the software is updated. When you update the software, prepare for any contingency: follow the proper procedures according to the operation method provided by the tablet terminal manufacturer, after taking the backup measures such as copying the data to a PC, etc. For the details, please confirm with the tablet terminal manufacturer.

### 2.3.2 Tablet holder attachment

---

This is a fixture to hold your tablet terminal inside the cab. Prepare one that can fix your tablet terminal firmly.

---

### 2.3.3 Wi-Fi router

---

To use the ICT function, it is necessary to connect the tablet terminal to the GNSS controller via wireless LAN and then connect to the Smart Construction server via the mobile phone line. Therefore, prepare a Wi-Fi router (what is generally called a mobile Wi-Fi router) that can also be connected to the 4G/LTE line. The Wi-Fi router needs to satisfy the following conditions.

- Wireless LAN standards: IEEE802.11a/b/g/n/ac
- Number of Wi-Fi-enabled devices that can be connected at the same time: 2 units or more

The Wi-Fi routers validated for operation are “809SH” and “FS040W.” For other Wi-Fi routers, contact the Support Center.

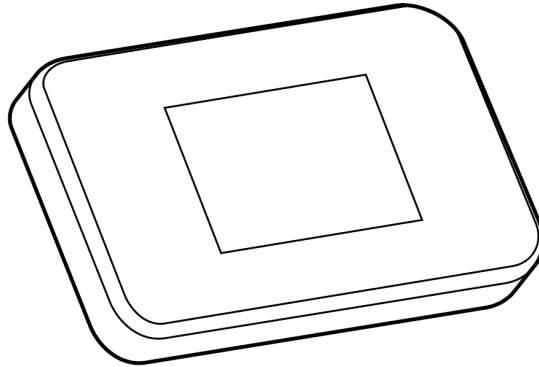

### 2.3.4 Tablet power feeding apparatus

---

#### **WARNING**

##### **THERE IS A POSSIBILITY OF SERIOUS INJURY OR DEATH.**

- First, place the work equipment lock lever of the Kit-equipped machine in the locked position and stop the engine. Then, attach/detach or adjust the position of the power feeding apparatus and charging cable.
- Securely install the tablet holder attachment, tablet power feeding apparatus, and charging cable in a place meeting all the following conditions so that they cannot fall off.  
If the field of view is obstructed while operating the Kit-equipped machine, a serious accident resulting in injury or death may occur. Their interference or falling may result in injury to the operator or damage to the tablet terminal or others.
  - The tablet terminal and tablet holder attachment do not block the field of view when operating the Kit-equipped machine.
  - The tablet terminal and tablet holder attachment do not touch hands, etc. of the operator when operating the Kit-equipped machine.
  - The tablet terminal and tablet holder attachment are fixed firmly in a way that they do not fall off.

#### **Notice**

- To prevent the battery from running out while using the tablet terminal, connect the tablet power feeding apparatus and use it while feeding the power to the tablet terminal.

---

---

### **Supplementary explanation**

- The tablet terminal operates with it connected to the Wi-Fi router but is not operable by connecting to a mobile phone line.
- Commercially available tablet power feeding apparatuses are of various types such as those that take power from the machine body and portable large-capacity batteries. Prepare the one that suits your tablet terminal.
- The cab is equipped with a 24 V cigarette lighter and a 12 V power socket.
- Many tablet terminals cannot be used for a long time with no power supply received. Use the tablet while connected to a power feeding apparatus.

## **2.3.5 Local storage device**

---

You can use a Micro SD card as local storage by connecting an SD card reader to your tablet terminal via USB. The SD card reader confirmed for operation is Anker USB-TypeC 2-in-1 card reader. For other SD card readers, contact the Support Center.

### **Supplementary explanation**

- The operation is confirmed with the following Micro SD card that has been formatted as FAT32.  
SanDisk microSD 32GB UHS-I Class10

# 3. Before starting work

---

## ⦿ Prerequisites for starting work

Before starting work with the Kit, make sure that the following are complete:

- With every part of the Kit installed correctly, it is verified that the system operates properly.
- The tablet holder attachment is installed correctly.
- The machine/bucket has been calibrated, and the Machine Guidance function has reached the standard accuracy. Otherwise, retry the calibration.
- Check that the Pilot application is the latest version.

## 3.1 Points to note

### CAUTION

#### **THERE IS A POSSIBILITY OF INJURY.**

Do not approach the Kit-equipped machine if not necessary. If you need to approach the Kit-equipped machine, secure safety through following the procedures below.

- Tell the worker of the Kit-equipped machine before you approach the machine.
- Approach the Kit-equipped machine after the worker of the machine sets the work equipment lock lever at the “lock” position and gives the signal.
- When getting into or out of the Kit-equipped machine, do not jump in or out of it. Make sure to get on and out of the machine while supporting your body at three points.
- Use elevating equipment as needed.

## 3.2 Workflow

### Using Machine Guidance

1 Perform look around inspection for the Kit.

[3.3](#) 

2 Check the mounting condition of the Kit.

[3.4](#) 

3 Use the Machine Guidance function.

#### 3-1 When you want to make full use of the 3D Machine Guidance function

Use the 3D Machine Guidance function.

[4.1](#) 

Set the 3D Machine Guidance.

[4.2](#) 

#### 3-2 When you want to use the Machine Guidance function without configuring complicated settings

Use 3DMG Basic.

[5.8](#) 

#### 3-3 When you do not use the satellite information

Use the 2D Machine Guidance.

[5.7](#) 

#### 3-4 When the function is not yet set or the tablet or a part is replaced

Connect to Wi-Fi.

[3.5](#) 

Install the application on the tablet.

[3.6](#) 

(The work of 3-2 is also required.)



---

---

**3-5 When changing the worksite or checking the accuracy**

Load the project file.







▶ [3.9](#) 

Check the cutting edge position accuracy.

▶ [3.10](#) 

**3-6 When customizing the Machine Guidance function**

- Set the GNSS.
- Set the bucket.
- Set machine calibration.
- Use the geofence function.
- Use the simulator function.
- Perform system management.
- Configure the administrator settings.

- ▶ [5.1](#)   
[5.2](#)   
[5.3](#)   
[5.5](#)   
[5.6](#)   
[5.9](#)   
[5.10](#) 

**Payload**

**1** Start up the payload meter.

▶ [6.1](#) 

**2** Use the payload meter.

▶ [6.3](#) 

**2-1 At initial use, at model change, etc.**

Set up the payload meter.

▶ [6.1](#) 

**2-2 At initial use or at bucket/model change, etc.; or monthly**

Calibrate the payload meter.

▶ [6.2](#) 



## 3.3 Equipment look around inspection

Once a day, before starting the engine, inspect for loose bolts and nuts, loose wiring connectors, and play.

### 3.3.1 Checking installation of GNSS antenna

1. Check that the mounting bolts on the GNSS antenna are not loose. If they are loose, retighten them (tightening torque: 32 N·m).

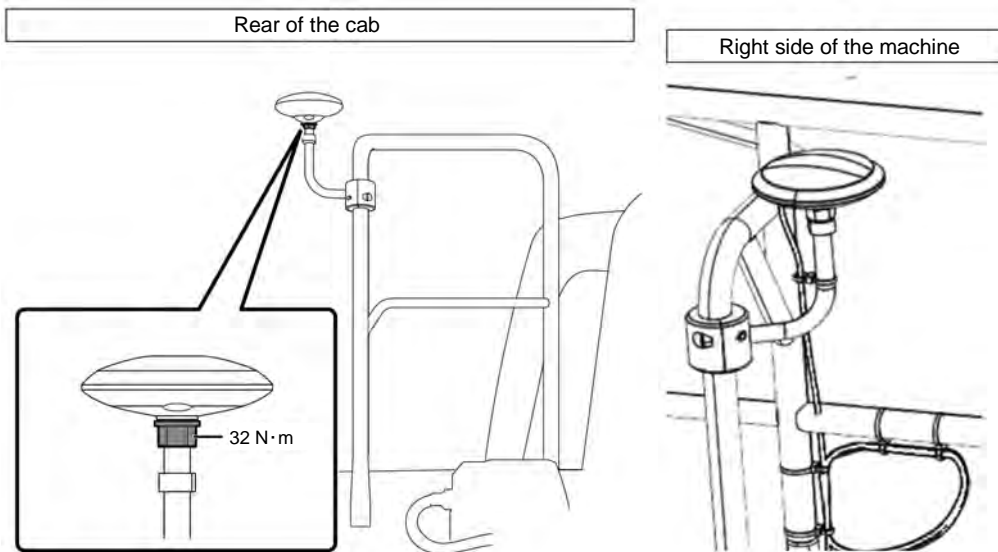

2. Tighten while pressing the connector of the GNSS antenna in the arrow direction for connection. Tighten it securely so that it will not come loose during operation.

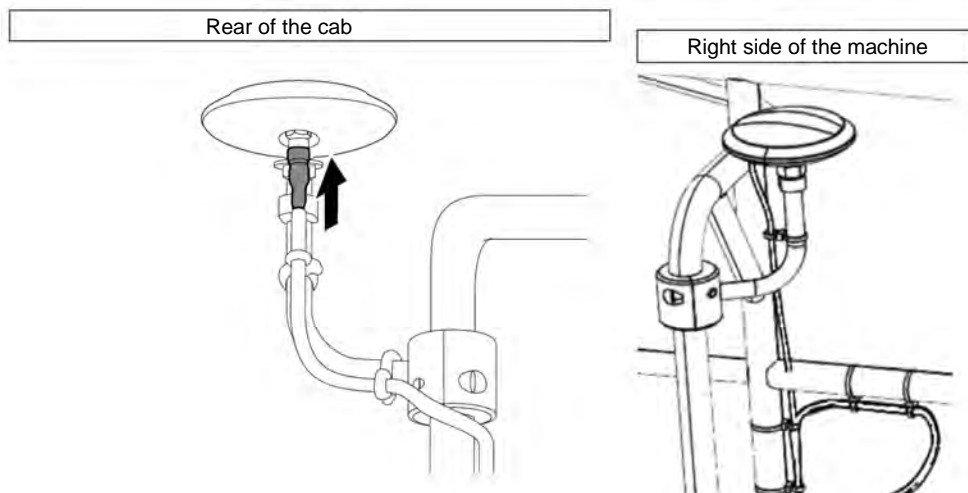

### 3.3.2 Checking installation of GNSS controller

Check that the GNSS controller is firmly fixed.  
If the GNSS controller is not firmly fixed, retighten it.

## 3.4 Checking installation

1. Check that any parts installed with the Kit have not fallen off and that no wrong part is installed. Be sure to install a single IMU for the boom, arm, bucket, and the machine body. Installing identical IMUs may cause a trouble (for example, installing two boom IMUs).
2. Confirm that the system operates normally.
  - (1) Turn on the disconnect switch.
  - (2) Turn on the key switch and the power. (You do not need to start the engine.)

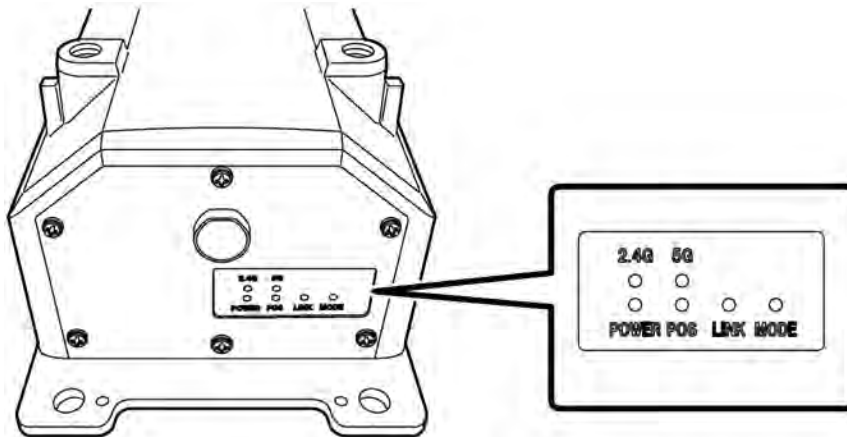

- (3) Check the LED light of GNSS controller.

|       |   |
|-------|---|
| POWER | Power: Lights up when the key switch is on.   |
| POS   | Confirmation on positioning: Lights up in the state of GNSS independent positioning or above.<br>It turns off in the state of not-receiving or not-positioning.   |
| LINK  | Lights up when correction data is received.<br>It turns off while operation is being confirmed.   |
| MODE  | Blinks in RTK-Float. Lights up steadily in RTK-Fix.<br>It turns off while operation is being confirmed.   |
| 2.4G  | Lights up while 2.4 GHz Wi-Fi is used.  |
| 5G    | Lights up while 5 GHz Wi-Fi is used.<br>* In Japan, it is prohibited to use 5 GHz Wi-Fi outdoors. Therefore, the light does not turn on when it is used in Japan. |

3. Confirm that the harness, etc. are not interfering or bent. Start the engine and slowly move the bucket, arm, and boom of the Kit-equipped machine to check.
4. Stop the engine to confirm that there is no oil leakage from the pressure sensor part under the boom.

## 3.5 Setting Wi-Fi

Connect the tablet terminal and GNSS controller via Wi-Fi router. The method for setting up the Wi-Fi router and tablet terminal differs according to the devices you use.

For setting up FS040W, follow the procedure below. Carry out the setting through referring to the setting-up procedures of FS040W and instruction manual of your device.

### Supplementary explanation

The methods shown here are only examples.

For the details, refer to the instruction manual of your device.

1. Confirm the SSID and password of the GNSS controller.
  - SSID: Serial number of GNSS controller

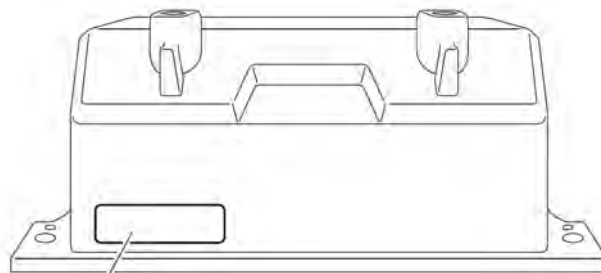

Position to display

- Password: Backward reading of SSID  
e.g. If the SSID is "Retro-48A4934916E4," the password is "4E6194394A84." Set the SIM card in the Wi-Fi router.
2. Start charging by connecting the Wi-Fi router to a PC using a USB cable. Prepare a charging cable suitable for your Wi-Fi router.  
When connected, the driver is automatically installed on your PC.
  3. Start the settings screen of Wi-Fi router on your PC and login.
  4. Set the host IP address "192.168.128.1" on the DHCP settings screen of Wi-Fi router. Change the value of subnet mask as needed.
  5. Change the SSID and password of the Wi-Fi router according to the SSID and password of the GNSS controller confirmed in the procedure 1.
  6. Disable privacy separator functions of the Wi-Fi router.  
If the privacy separator functions are enabled, the system does not function because information cannot be exchanged between terminals.
  7. Reflect the setting of the Wi-Fi router.  
The Wi-Fi router and GNSS controller are connected.
  8. Close the settings screen of the Wi-Fi router and remove the router from the PC.
  9. Enable the Wi-Fi functions using the tablet terminal.  
The SSID of GNSS controller is displayed in the list of the Wi-Fi network.
  10. Select the SSID of GNSS controller and input the password.  
The Wi-Fi router, GNSS controller, and tablet terminal are connected via Wi-Fi.

## 3.6 Installing application

### Notice

- When making a remote connection with a tablet terminal of Android 11 or later version, upgrade the remote support application to the latest of v1.7.0 or later version.

Download Smart Construction Pilot, the necessary application software, from Google Play Store and install it on the tablet terminal.



Input the search word "Smart Construction Pilot" on Google Play Store.

If Smart Construction Pilot is installed on the tablet terminal without problems, the icon below is displayed on the home screen.



### Supplementary explanation

- To use the Smart Construction Pilot, you must agree on the terms of use. When you start Smart Construction Pilot for the first time, the terms of use is displayed. Be sure to confirm the details.
- Install Smart Construction Pilot after connecting the tablet terminal to the Internet. You can use any types of connection (e.g. mobile Wi-Fi, public/corporate Wi-Fi).

When installation of Smart Construction Pilot is completed, start the settings so that the GNSS controller and tablet terminal can communicate via Wi-Fi router.

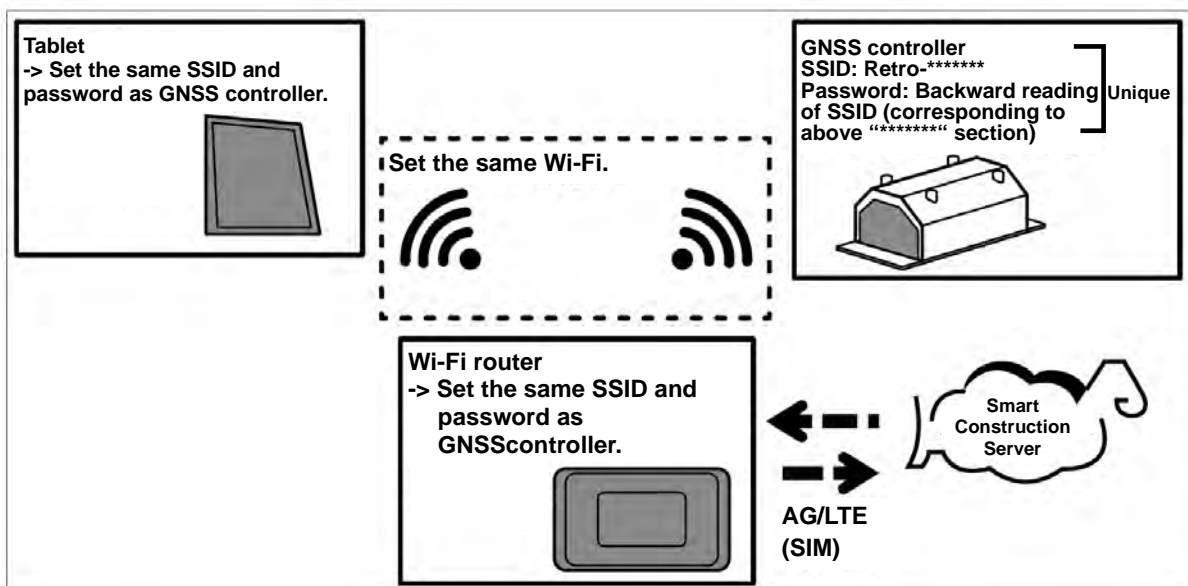

## 3.7 Starting Smart Construction Pilot

1. Tap “Smart Construction Pilot“ on the tablet screen.  
The screen below is displayed.



2. Select the language to be used and region, then tap “OK.“



### Supplementary explanation

- Settable regions vary by the selected language.

3. The terms of use is displayed.

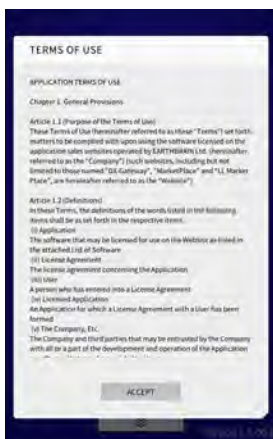

- Slide downward to confirm the details and tap “ACCEPT.”  
If you do not need to see the terms of use from the next time onward, select “Do not show this again” before accepting it. The start-up screen is displayed.



### Supplementary explanation

- When “Simulator Mode” is set to “ON” on the “Common Settings” screen, only “Machine Guidance” is displayed on the start-up screen.

- Tap “Machine Guidance.”
- Tap “OK.”  
The main screen is displayed.

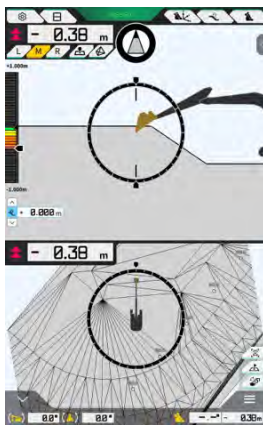

- If machine calibration has not been carried out, carry it out.  
Refer to the Instructions for Installation. The distribution destination of the Instructions for Installation, the ID, and the password are found on the paper included with the product.

## 3.8 Setting common items

Set the language, region, unit of length, and unit of weight that are used with Smart Construction Pilot.

1. Tap  on the start-up screen to open the “Common Settings” screen.



2. Set “Language,” “Region,” “Unit of Length,” “Weight Unit,” “Coordinates,” etc. and tap “✓.”

## 3.9 Project file

The following operations can be performed on the “Project File” screen for the project files to be used with the Machine Guidance function (design drawings 3D data).

|                        |  |
|------------------------|--|
| Download project files | Download project files from the Smart Construction server. |
| Create project files   | Create new project files.                                  |
| Select project files   | Select and load project files on the tablet.               |
| Select design surface  | Select the design surface to be used in the project.       |
| Edit project files     | Edit project files.  |

---

## Supplementary explanation

- When the application comes online on the tablet terminal of the construction machine for which a project file has been associated by Pilot Web, the target project file will be downloaded automatically, and the following screen will be displayed. Tapping “✓” opens the “Project File” screen.

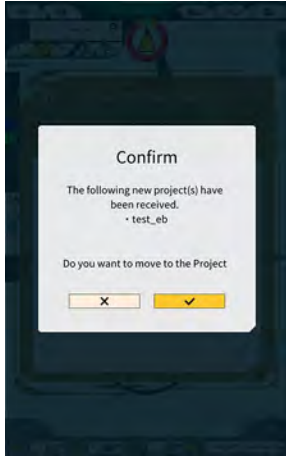

1. Tap  to open a menu.



2. Tap “Project File” to open the “Project File” screen.





---

## 3.9.1 Acquiring project files

---

Project files can be acquired from the server or local storage.

### ■ Downloading from server

1. Tap  to open the “Project File Download” screen.  
On the “Project File Download” screen, the list of the project files registered to the Smart Construction server will be displayed.



2. Tapping  of the target project file displays the confirmation window.

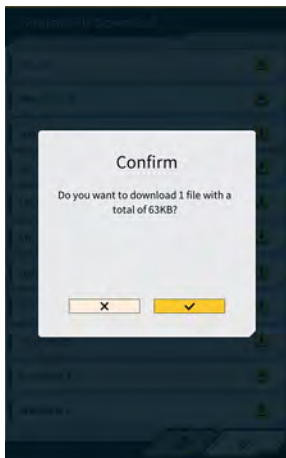

3. Tap “✓” to start downloading.

- After downloading, tap “✓” in the confirmation window to specify the target project file.

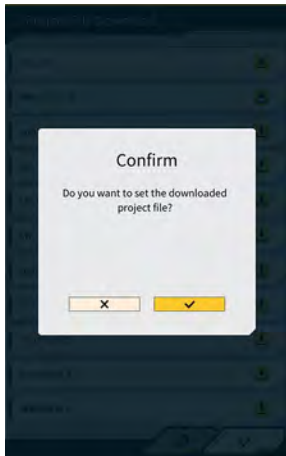

## ■ Acquiring from local storage

- Tap  to select a project file with “.rpz” extension using the folder selection function of the tablet terminal.
- Tap “✓” in the confirmation window to acquire a project file.



3. After acquiring a project file from a local storage, tap “✓” in the confirmation window to specify the target project file.



## 3.9.2 Creating project files

Create project files on the tablet terminal.

1. Tap  to open the “Project Settings” screen.



2. Enter a project name at “Project Name.”
3. Tap  to move to the “Localization/Projection” settings screen, and enter the coordinate system.

### <Localization settings>

- Tap  to move to the “Add Control Point” screen.

#### ▶ Adding a control point

- Enter the name of the control point.
- Enter the distances N, E, and Z, from the reference point.
- Align the control point and the bucket cutting edge at the left edge/center/right edge of the cutting edge, and tap  to acquire the coordinates.

- To use “H Use”/“V Use”, tap “ON”/“OFF.”



- Tap  to discard the control point.
- After finishing configuring all settings, tap “✓” to save the settings.

### <Projection settings>

- Tap “Projection” at the top of the screen.

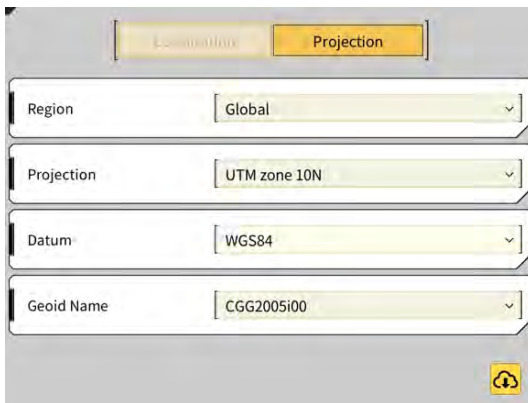

- Set “Region,” “Projection,” “Datum,” and “Geoid Name.”

### Supplementary explanation

- Tapping the “Projection” or “Geoid Name” field and entering a character string enables narrowing of displays to the items containing the character string.
- To save the settings, tap “✓” at the bottom right of the screen.
- If the required file has not been downloaded, a confirmation window will appear. Tap “✓” to download the file.

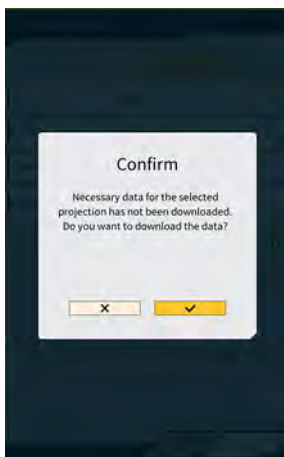

- Tap  to acquire the latest setting file from the server.

- 
4. To create a simple design surface, tap  to move to the “Create Simple Design Surface” screen.  
The coordinates of the cutting edge can be acquired and measured at 1 to 3 points.





**(1-point measurement)**



- Tap “Flat Plane” and tap → at the bottom right of the screen.

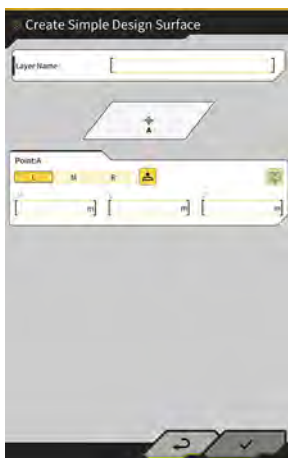

- Enter a layer name.



- Align the left edge/center/right edge of the cutting edge with the measuring point and tap  to acquire the cutting edge coordinates.

- If you have acquired topography measurement points in advance, you can acquire the measured cutting edge coordinates by tapping . Select a point of the target layer and tap “✓” at the bottom right of the screen. The coordinate information can be checked by tapping .



### Supplementary explanation

- The display color of the point can be changed via the “Topographic Survey List” screen.
- Tap “✓” at the bottom right of the screen to save the design surface. To use the design surface in the project, tap “✓” in the confirmation window.

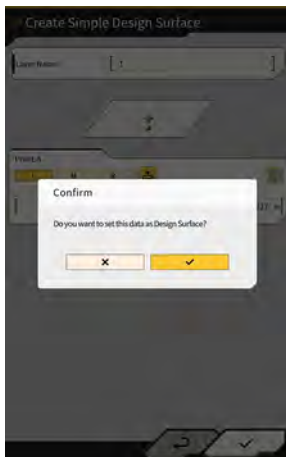

## (2-point measurement)

- Tap “2 Point Sloping Plane” and tap → at the bottom right of the screen.

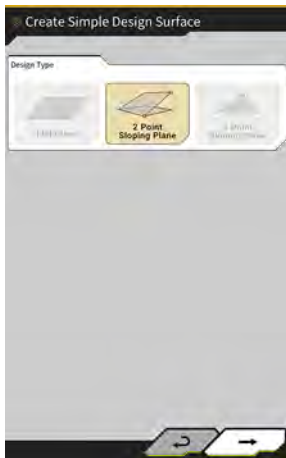

- As with 1-point measurement, enter a layer name and acquire cutting edge coordinates.



- Enter the slope information. Tap  to select an input method of slope (%/ratio/angle).
- Tap “✓” at the bottom right of the screen to save the design surface.  
To use the design surface in the project, tap “✓” in the confirmation window.

### (3-point measurement)

- Tap “3 Point Sloping Plane” and tap → at the bottom right of the screen.

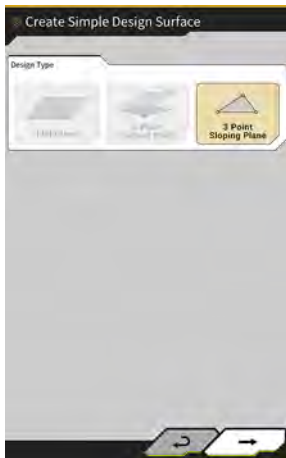

- As with 1-point/2-point measurement, enter a layer name and acquire cutting edge coordinates.



- Tap “✓” at the bottom right of the screen to save the design surface.  
To use the design surface in the project, tap “✓” in the confirmation window.

### ■ Creating design surface from line work

Create a design surface for the Machine Guidance from a line work in the project file. Enter a width and offset in the Z direction for the selected line work to create a design surface.

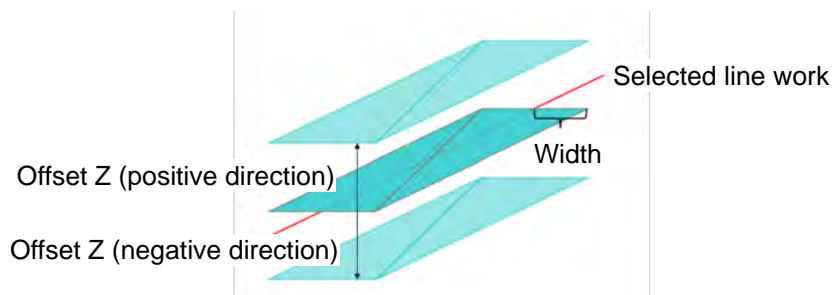





1. On the “Project File” screen, tap  of the target project file for adding a design surface to open the “Project Settings” screen.



2. Tap  to open the “Create Design Surface” screen.



### Supplementary explanation

- Tap  of the created design surface to edit the design surface.
  - Tap  to delete the created design surface.
3. Position  (crosshair cursor) on the target line work for creating a design surface.
  4. Enter a layer name, width, and offset Z and then tap “✓.”

## Notice

- Creation of a design surface may be incomplete in the following cases.
    - The number of triangles (TIN) consisting of a design surface exceeds 200.
    - Extension of the selected line work exceeds 200 m.
    - The selected line work is largely deflected.\*
    - The entered width is too large.\*
    - The line work contains an extremely small line segment.\*
- \* In these cases, the creation of a design surface may fail with the following message display.



### Supplementary explanation

- You can check the created design surface by selecting the layer from the pull-down menu of “Design surface” on the “Project Settings” screen.



---

### 3.9.3 Selecting project files

---

1. Tap a project file in the list to make it hatched in yellow.



2. Tap "✓" at the bottom right of the screen.
3. Tap "✓" in the confirmation window to set the selected project file.

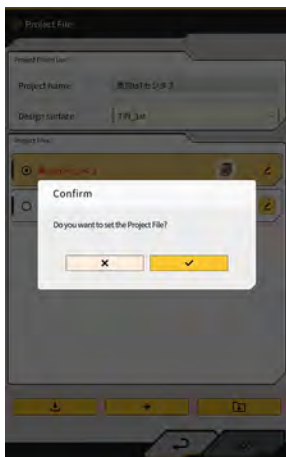

---

## 3.9.4 Selecting project display layer

---

1. Tap the pull-down menu of “Design surface.”  
A list of design surfaces that exist in the project file will be displayed.



2. Tap the design surface to display to select it.
3. Tap “✓” at the bottom right of the screen. When the confirmation window appears, tap “✓.”

---

## 3.9.5 Editing project files

---

1. Tap  of the target project file.



- Each item can be edited.  
(Refer to “3.9.2 Creating project files” to edit project name, edit coordinate system, select design surface, and create simple design surface.)



Layers to be displayed can be selected.

When a check mark is placed in the layer in the list, the layer will be displayed on the Machine Guidance screen. When a check mark is removed, the layer will not be displayed.

Tap a color button between “TIN” and  to change the color of the display layer.



- When you finish editing, tap “✓” at the bottom right of the screen.  
When the confirming window is displayed, tap “✓” to save the settings.

## 3.10 Checking cutting edge position accuracy

Before starting the work of a day, check that the system can detect the cutting edge position correctly.

### 3.10.1 Preparation for checking

1. Turn on the disconnect switch.
2. Turn on the key switch and the power. (You do not need to start the engine.)
3. Turn on the tablet terminal.

### 3.10.2 Checking GNSS information

1. If a reference point/standard pile is set at the operation worksite, move the machine to the vicinity of the reference point/standard pile.
2. Tap  to open a menu.



3. Tap "GNSS Settings."



4. Tap “GNSS Info” to open the “GNSS Info” screen.



### Supplementary explanation

- You can check the number of captured satellites for each satellite on the “GNSS Info” screen.
5. Confirm that “Vertical RMS” and “Horizontal RMS” of “Main Antenna” are 0.02 or less. If they are not less than or equal to 0.02, wait until the satellite reception is in good condition and then check again.
  6. Tap “✓.”

## 3.10.3 Checking cutting edge position accuracy

To check the accuracy of the cutting edge position, use Smart Construction Pilot on the tablet terminal. For how to start Smart Construction Pilot, refer to “3.7 Starting Smart Construction Pilot.”

1. Tap  to open a menu.



2. Tap “Guidance Settings.”

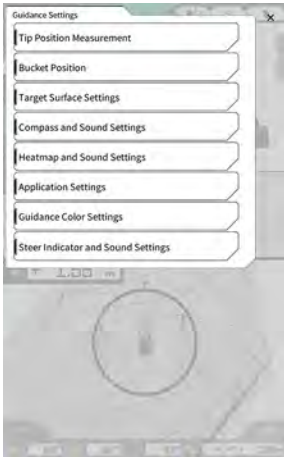

3. Tap “Tip Position Measurement.”

4. Select a control point or tap **+** to register the comparison point. (For details, refer to “4.2.1 Measuring cutting edge position.”)



5. Set the work equipment to the position 1 as shown in the figure below.

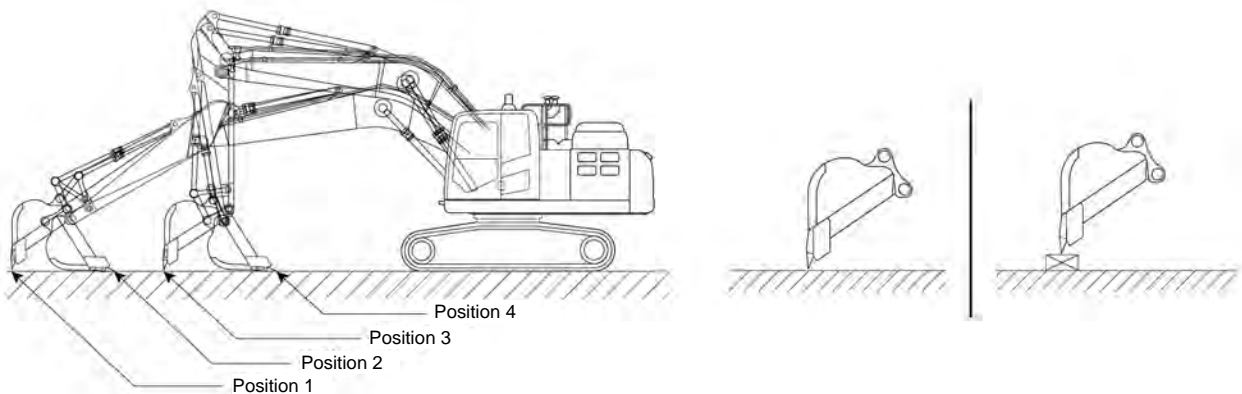



- Keeping the position 1, select the left edge/center/right edge of the bucket cutting edge, place the bucket cutting edge on the reference point/standard pile, and then tap .

The coordinates of the cutting edge recognized by the system will be displayed under “Cutting Edge Position.”

If the cutting edge cannot be placed on the reference point, measure  $\Delta Z$  shown in the figure (vertical distance between the reference point and the bucket cutting edge), enter it in “ $\Delta Z$ ” under “Cutting Edge Position”, and then tap .

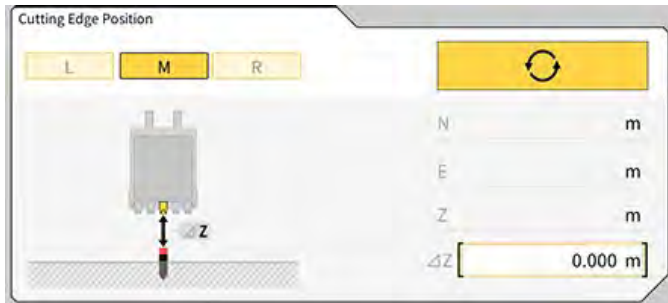

- The difference between the measured bucket cutting edge position and the reference point position will be displayed under “Difference.”

Check whether it is within the standard value.



- If the values are within the standards: Check the cutting edge accuracy in the same way with the positions 2/3/4. If all the values are within the standards, the construction accuracy will be secured.

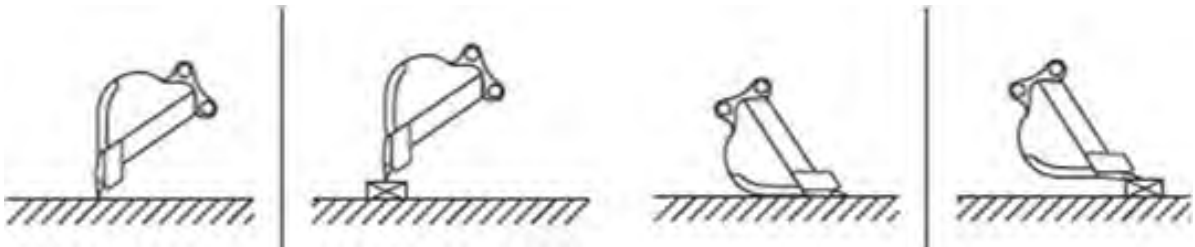

- If the values are not within the standards: Confirm that there is no looseness or detachment of the mounted devices, and carry out bucket calibration. For further details, refer to “5.2.2 Bucket calibration.”

### Supplementary explanation

- After calculating the cutting edge coordinates, by tapping “MATCHING” in the “Offset” section, the N, E, and Z displayed at “Difference” will be offset and the construction machine in the Machine Guidance screen will be displayed.
- Tap “RESET” to delete the offset values that have already been entered. Offset values can be entered manually.
- To reflect the offset values that have been set, tap “✓” at the bottom right of the screen.

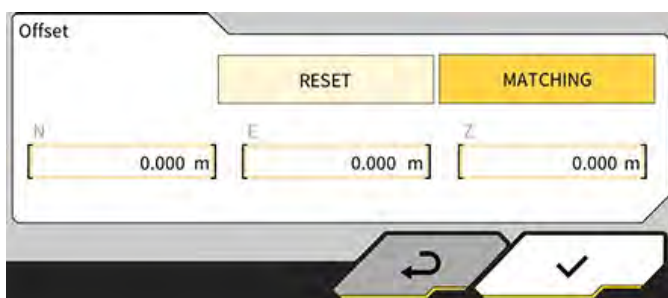

# 4. How to use Smart Construction Pilot

## 4.1 Using 3D Machine Guidance function

### 4.1.1 Displaying main screen

1. On the start-up screen, tap “Machine Guidance.”  
The data required for a start-up is loaded, and the main screen is displayed.

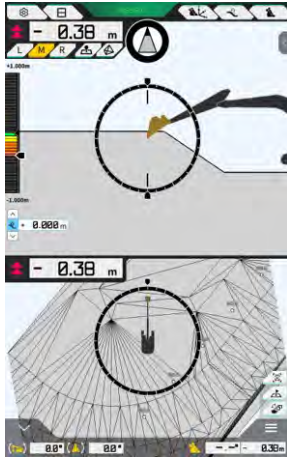









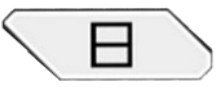





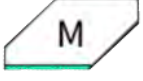
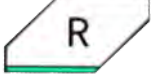

If the system fails in acquiring the required data, an error will be notified.



2. If the calibration has not yet been done, do it according to the Instructions for Installation. The distribution destination of the Instructions for Installation, the ID, and the password are found on the paper included with the product.

### 4.1.2 Main screen operations

The functions of the icons displayed on the main screen are as follows:

| Icon  | Name                                     | Function  |
|---|--|---|
|  | Menu button                              | Displays the menu.  |
|  | Display split switching button           | Switches the display between full, two-split, and three-split screen displays.  |
|  | GNSS status button                       | Displays the GNSS status code information.  |
|  | Cutting edge position measurement button | Moves to the “Tip Position Measurement” screen.   |
|  | Target surface offset setting button     | Moves to the offset settings screen for the target surface. After setting, the offset surface from the selected slope is displayed. |

| Icon  | Name   | Function  |
|---|--|---|
|    | Bucket button  | Displays the bucket file settings screen.   |
|    | Left button  | Switches the distance and angle to the slope and the cutting edge position to the left when viewed from the operator.   |
|    | Center button  | Switches the distance and angle to the slope and the cutting edge position to the center when viewed from the operator.   |
|    | Right button   | Switches the distance and angle to the slope and the cutting edge position to the right when viewed from the operator.  |
|    | Topography measurement point addition button                         | Records the current cutting edge position. By tapping this, the measured point is added to the list of topography measurement points.   |
|    | Target surface TIN (Triangulated Irregular Network) selection button | Moves to the target surface TIN selection screen in the full-screen mode (refer to “4.1.4 Target surface TIN selection view”). Once the selection is completed, the screen returns to the original screen. Selected TIN and two or more TINs in the specified range of angles are selected. |
|  | View switching button  | Displays the view switching screen.   |
|  | Mini map button  | Displays a mini map that gives you a bird’s eye view of the entire worksite.  |
|  | Reset button   | Resets the display position of the construction machine to the initial display position.  |
|  | Target surface offset setting button                                 | Increases/decreases the vertical offset value of the target value.  |
|  | Facing angle compass   | Displays the rotation angle required to face (head-on) the target surface on the gauge.   |
|  | Bucket bottom rotation angle display                                 | Displays the rotation angle required to make the bottom of the bucket parallel to the target surface.   |
|  | Distance to cutting edge   | Displays the distance from the target surface to the cutting edge.  |
|  | Subwindow display 1  | Displays the subwindow. A display element can be turned on/off in the subwindow.  |

| Icon  | Name   | Function  |
|---|--|---|
|  | Subwindow display 2  | Displays the subwindow. You can display the roll angle, pitch angle, bucket bottom rotation angle, and the distance to the cutting edge of the construction machine in the subwindow. |
|  | Switching between bucket name/angle and distance to design surface | Switches the display between the bucket name/angle and the distance to the design surface.  |

### Supplementary explanation

TIN (Triangulated Irregular Network): A digital data structure that represents the ground surface with triangles facets. This application uses it to set the target surface.

### ■ Displaying menu

Tap .



### ■ Switching display split type

Tap  to switch the display format (full screen, two-split, and three-split displays).

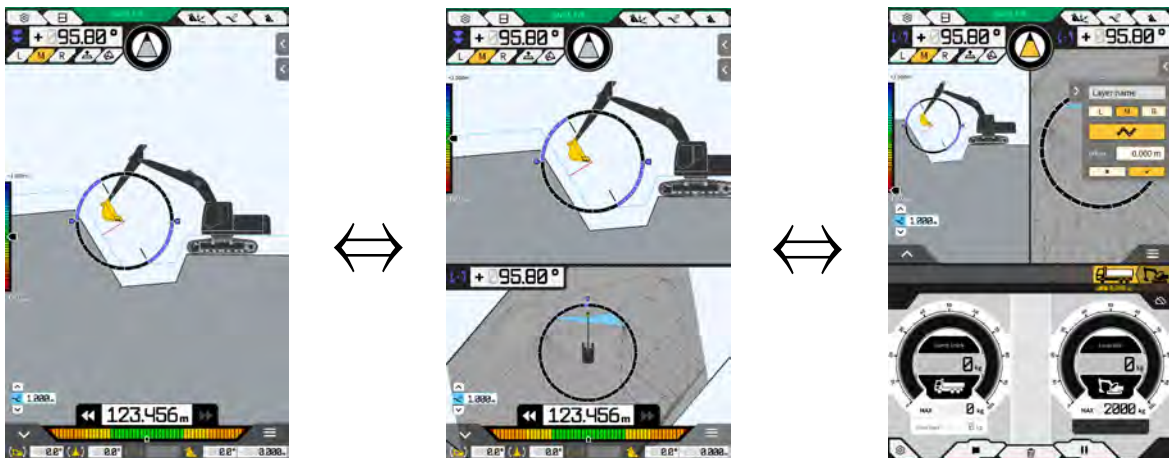

## Supplementary explanation

- In the three-split display format, the Machine Guidance screen is displayed in the two-split display format in the upper section, and the payload is displayed in the lower section. The Machine Guidance function and the payload function can be used simultaneously.

## Switching view

Tap  to display the view switching screen.  
Tapping each icon switches the display as follows.

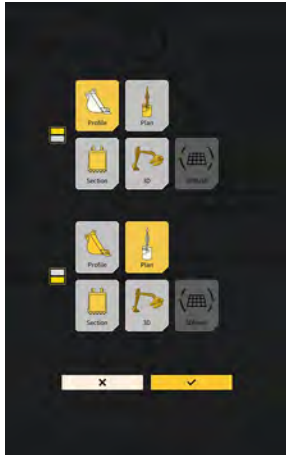

- “Profile“: Viewpoint on the operator’s lateral side
- “Section“: Viewpoint on the operator’s front side
- “Plan“: Sky viewpoint
- “3D“: 3D free viewpoint
- “3DMesh“: 3D mesh mode (tilt bucket only)

## Switching cutting edge position

By tapping “L”, “M”, or “R”, the position of the cutting edge displayed on the screen is switched to the left, center, or right.

## Displaying GNSS information

By tapping , the “GNSS Info“ screen is displayed.



---

## ■ Adding topography measurement point

By tapping , the current cutting edge position is recorded.

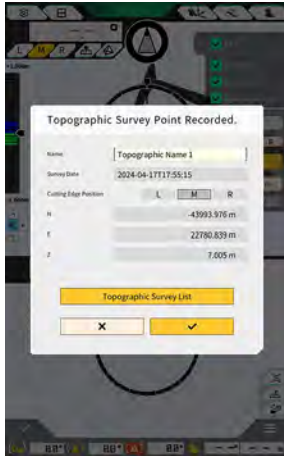

You can edit the measurement point name when you have tapped the record button.

Tap “Topographic Survey List” to display a list of measurement points. To save the measurement point, tap “SAVE.”

## 4.1.3 Guidance view operations

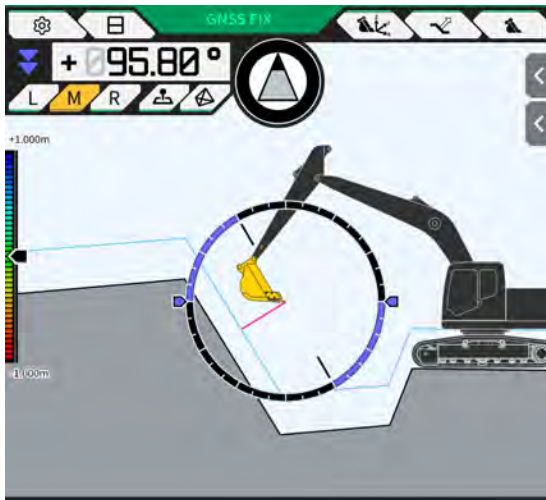

---

The guidance view on the main screen displays the design surface and the Kit-equipped machine. You can slide or zoom in/out the display with your fingers.

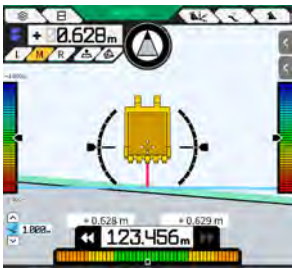
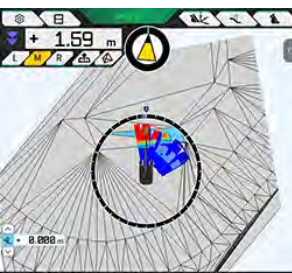

- Swiping (sliding a finger on the screen) slides the displayed content.
- Pinching out (moving two fingers apart on the screen) zooms in the displayed content.
- Pinching in (pinching two fingers together on the screen) zooms out the displayed content.

By tapping , the viewpoint can be switched.

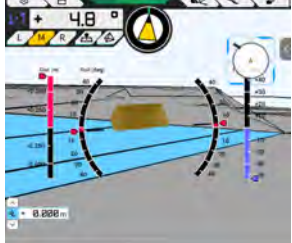
| View  | Viewpoint                                | Function  |
|---|--|---|
|    | Viewpoint on the operator's lateral side | You can check the positional relationship between the bucket and design surface from the viewpoint on the lateral side of the Kit-equipped machine. |
|    | Viewpoint on the operator's front side   | You can check the positional relationship between the bucket and design surface from the viewpoint of the operator.                                 |
|   | Sky viewpoint                            | You can check the worksite position in a bird's eye view from the sky.  |
|  | 3D free viewpoint                        | You can check the current construction status with a 3D image of free viewpoint.  |
|  | 3D mesh                                  | You can check with 3D mesh when using a tilt bucket.  |

### Supplementary explanation

- The machine pitch can be fixed to 0 (horizontal) for display with the viewpoint on the operator's lateral side.
- The elevations of both ends of the bucket cutting edge can be displayed with the viewpoint on the operator's front side. Also, the bucket can be displayed in a horizontal state by fixing the roll of the machine.
- The bucket width line can be displayed with the sky viewpoint.
- A heat map can be displayed with the 3D free viewpoint and 3D mesh.

---

## 4.1.4 Target surface TIN selection view

---

By tapping  on the guidance main screen, the view will be switched to the target surface TIN selection view.

The surface highlighted in light blue in the center of the screen is selected as the target surface. The target surface can be moved by sliding the screen.



- By tapping “✓,” the target surface will be determined and the view will return to the previous screen.
- By tapping “CLEAR”, the selection of the target surface will be canceled and the view will return to the previous screen.
- By tapping , changes made in the target surface TIN selection view will be reset and the view will return to the previous screen.

### Supplementary explanation

- The target surface is displayed in the color set on the guidance color settings screen.

---

## 4.1.5 Destination setting view

---

By tapping the mini map, the destination setting view will be displayed in the full-screen mode. The destination setting view allows you to set the destination of the construction machine and display the shortest distance and route to the destination.

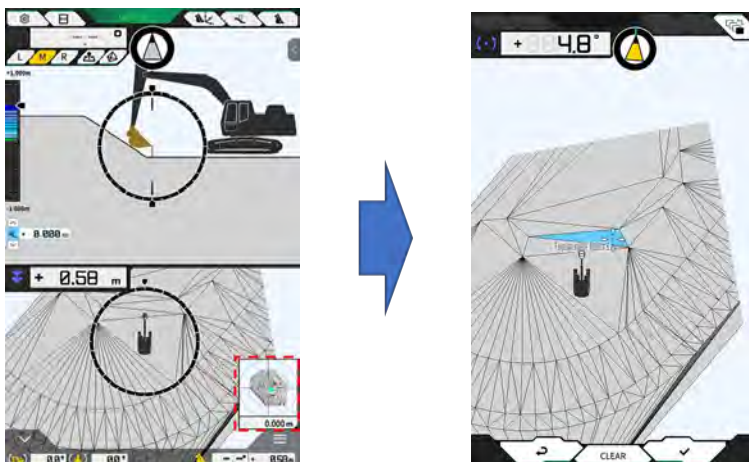

1. When the destination setting icon appears at the center of the screen, slide the icon to the work location.



2. Confirm the work location and tap “✓.”

The destination setting determination icon is displayed. The navigation mode is entered, and the view returns to the previous screen.

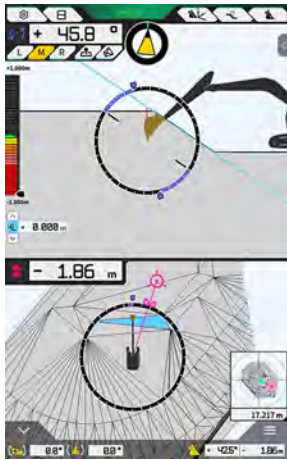

- The navigation mode displays the destination cursor, the shortest distance to the destination (effective accuracy: 0.001 m), and the shortest route line.
- By tapping “CLEAR”, the destination will be put into the unset state.
- By tapping ↶, changes will not be reflected and the view will return to the previous screen.

## 4.1.6 Other display items

### ■ Displaying bucket bottom rotation angle

The upper left angle indication shows the rotation angle required to make the bottom of the bucket parallel to the selected target surface, with an effective accuracy of 0.1 degrees. The direction of rotation will be indicated by the arrows at both ends and their colors.

The ring-shaped gauge displays in color the rotation angle required to make the bottom of the bucket parallel.

Pink: Open the bucket away from the machine

Blue: Close the bucket toward the machine

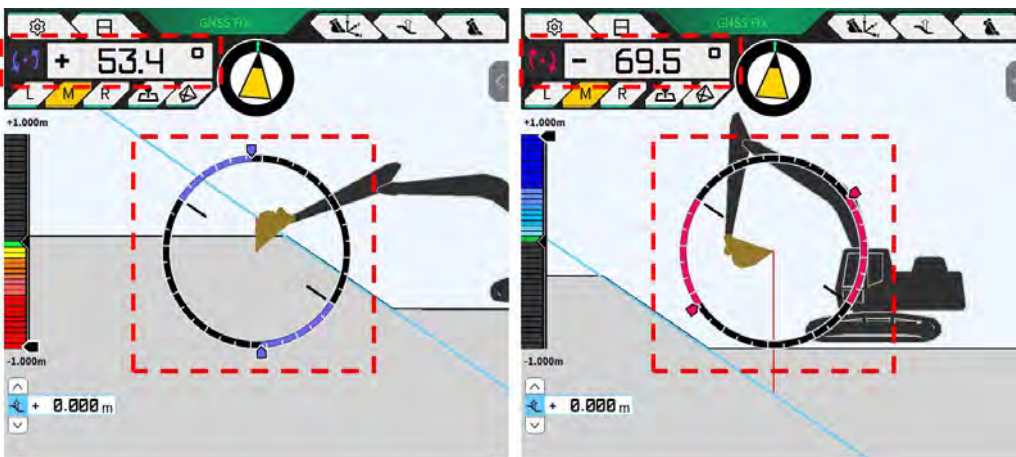

## ■ Displaying facing rotation angle

The rotation angle required to face (head-on) the target surface selected by the Kit-equipped machine is displayed on the gauge.

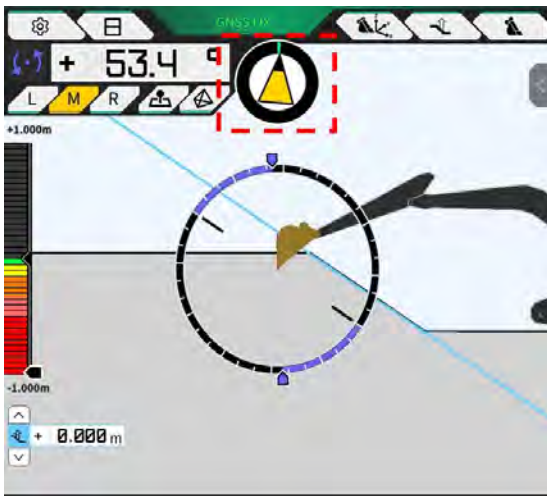

### Supplementary explanation

- A beep sounds from the tablet terminal according to the setting. Also, the angle range displayed on the gauge can be set. For how to set the facing angle and sound guidance, refer to “4.2.3 Changing facing angle compass and sound settings.”

## ■ Displaying distance to cutting edge

The distance from the selected target surface to the cutting edge or the distance from the offset surface to the cutting edge is displayed.

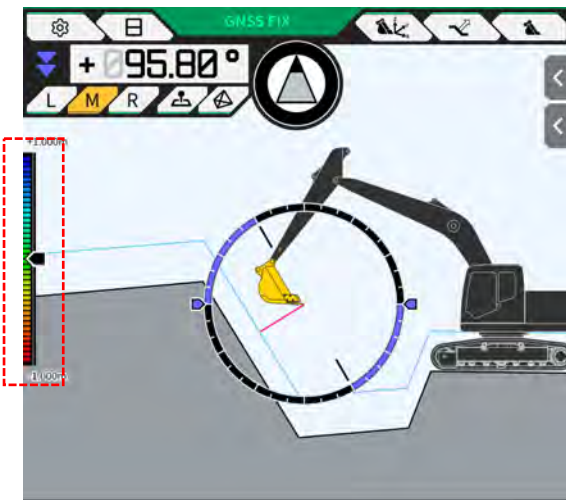

### Supplementary explanation

- A beep sounds from the tablet terminal according to the distance and the setting. For how to set the heat map and sound volume, refer to “4.2.4 Changing heat map and sound volume settings.”
- For how to calculate the distance (vertical or perpendicular to the design surface) and the number of effective accuracy digits, refer to “4.2.5 Changing application settings.”

In the case of front view

- The distance between the center of the bucket cutting edge and the target surface is displayed as a value/icon at the upper left of the screen.
- The distance between the left edge/right edge of the bucket cutting edge and the target surface is displayed as follows.
  - Displayed as a value in the center of the screen (elevation can also be displayed)
  - Displayed as linear gauges at both ends of the screen

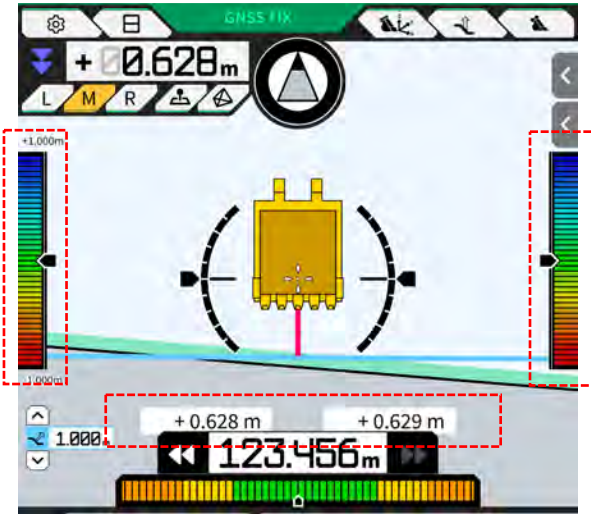

### ■ Displaying roll angle, pitch angle, bucket bottom rotation angle, and distance from target surface to cutting edge

By tapping  at the bottom of the screen, the pitch/roll angle of the machine and the rotation angle of the bucket bottom are displayed with an effective accuracy of 0.1 degrees, and the distance from the target surface to the cutting edge is displayed with the set effective accuracy.

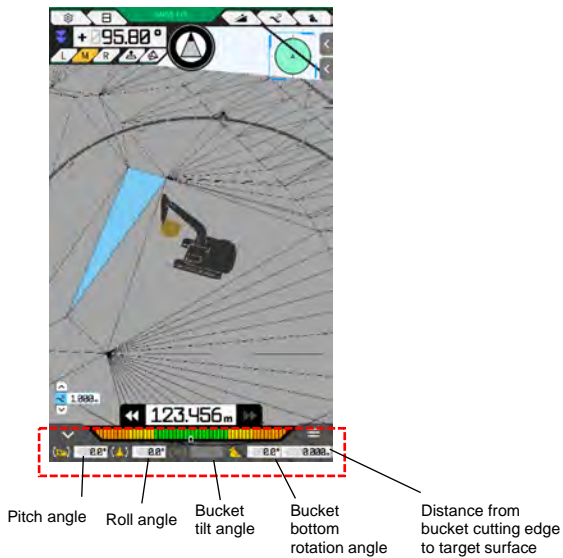

By tapping , the display will be hidden.

## ■ Displaying mini map

By tapping  at the bottom right of the screen, a mini map will be displayed. The mini map provides a bird's-eye view of the entire worksite. (The top indicates the north direction. The machine and the target point are displayed with a green  $\triangle$  and a pink  $\circ$ , respectively.)

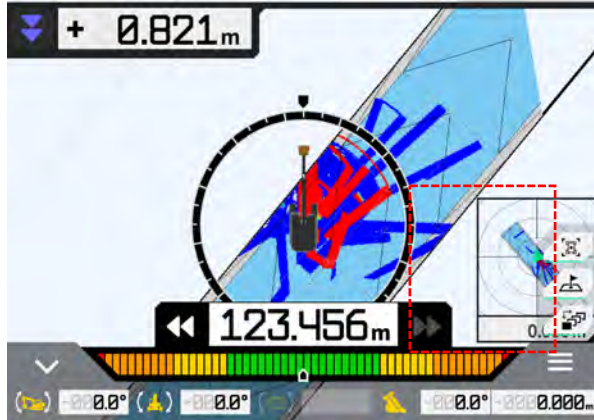

- By tapping  again, the mini map will be hidden.
- By tapping the mini map, the destination settings screen (refer to “4.1.5 Destination setting view”) will be displayed in the full-screen mode.

## ■ Displaying heat map

When “Heatmap” is set to “ON” on the “Application Settings” screen, the construction history is displayed on the heat map as a top view. The lowest surface where the bucket cutting edge or the bottom passed through with respect to the design surface can be checked with color. (For how to set the heat map colors, refer to “4.2.4 Changing heat map and sound volume settings.”)

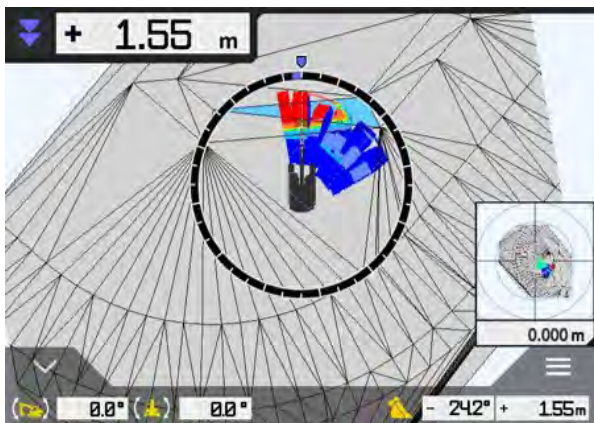

---

## ■ Displaying bucket name

By tapping the part indicating the bucket angle or the distance from the bucket cutting edge to the target surface at the bottom right of the screen, the display will be changed to the retrofitted bucket name. Tap the part again to restore the display of the bucket angle or the distance to the target surface.

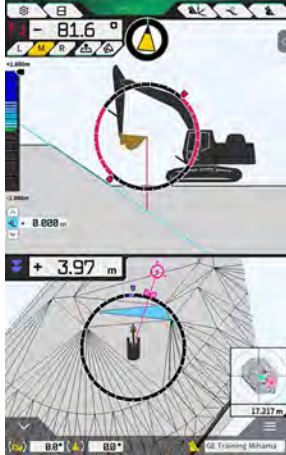

## ■ Displaying construction machine at initial position

By tapping  at the bottom right of the screen, the display position of the construction machine will be reset to the initial display position.

## ■ Displaying bucket width line

When “Bucket Width Line” is set to “ON” on the “Application Settings” screen, the bucket width line is displayed with the sky viewpoint.

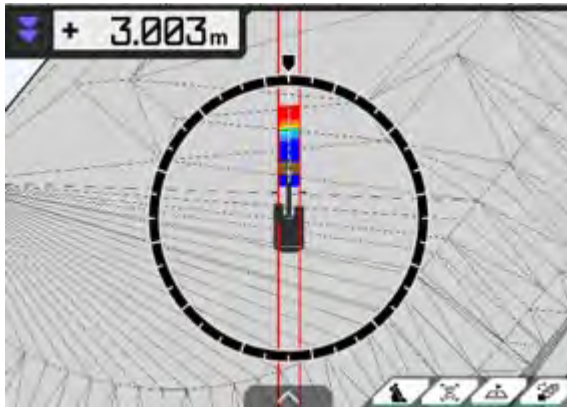

## ■ Displaying steer indicator

When using a project file containing a line work, selecting a line via  on the side panel displays the indicator on the guidance screen.

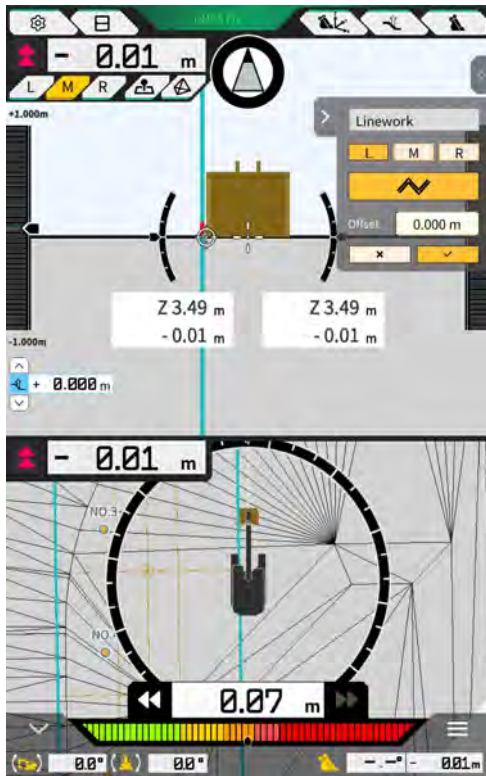

- You can enable/disable the function in the application settings. When “Steer Indicator Mode” is set to “ON,” the side panel will be displayed on the guidance screen. The default is “OFF.”
- When the two-split screen display is used, either “Middle” or “Bottom” can be selected at “Display Mode” for the display position of the steer indicator.

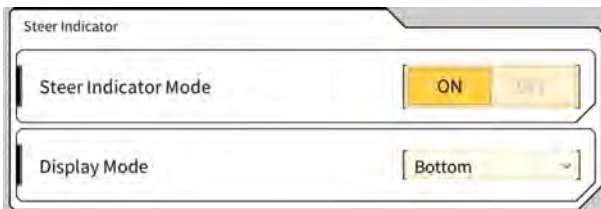

## 4.2 Setting 3D Machine Guidance

The “Guidance Settings” screen allows you to select the following functions in the menu.

|                            |  |
|----------------------------|--|
| Tip Position Measurement   | The coordinates of the bucket cutting edge position can be measured and the settings to offset with the specified value can be checked/changed.          |
| Bucket Position            | Coordinates can be measured at six points on the bucket bottom and the results can be checked.   |
| Target Surface Settings    | The offset values of the target surface can be changed.  |
| Compass and Sound Settings | The settings of the function to make a sound when the machine approaches the facing angle can be checked/changed.  |
| Heatmap and Sound Settings | The heat map can be displayed and the sound guidance volume can be set according to the distance between the bucket cutting edge and the design surface. |
| Application Settings       | The settings of Smart Construction Pilot can be checked/changed.   |
| Guidance Color Settings    | The display color on the guidance screen can be changed.   |

1. Tap  to open a menu.



2. Tap “Guidance Settings.”

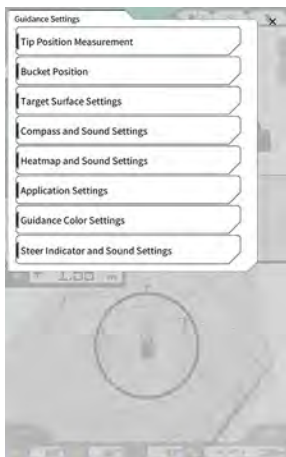

## 4.2.1 Measuring cutting edge position

1. Tap “Tip Position Measurement” on the “Guidance Settings” screen.

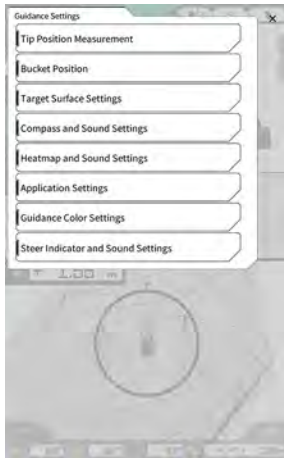

2. Set up by referring to the following:

- Selecting a reference point  
Select a saved reference point.

To set it manually, tap **+**, enter the name and N/E/Z values, and then tap “✓.”

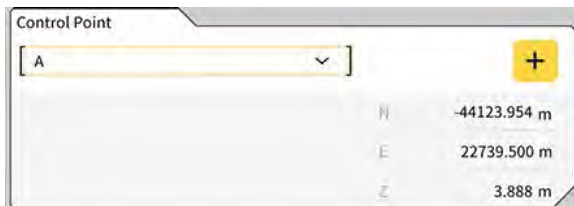

- Measuring the bucket cutting edge position

Select L/M/R of the cutting edge measurement position, enter the distance  $\Delta Z$  to the reference point, and then tap **↻**. After a few seconds, the coordinates of the cutting edge position will be displayed. If GNSS is not fixed, “RTK NOT FIX” will be displayed in place of **↻**. Fix GNSS before performing measurement.





- Offsetting the difference and reflecting it to the cutting edge  
When the cutting edge position is measured with the reference point set, the difference between the reference point and the cutting edge position will be displayed under “Difference.”  
By tapping **MATCHING**, the difference will be set to the offset value. Tap **RESET** to cancel the offset.

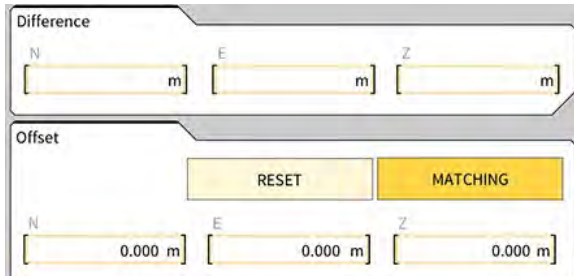

3. Tap “✓.” The changes will be reflected and the display will return to the previous screen. By tapping ↶, the changes will not be reflected and the display will return to the previous screen.

## 4.2.2 Changing target surface settings

Tap “Target Surface Settings” on the “Guidance Settings” screen to open the “Target Surface Settings” screen. Offset settings of the target surface and target surface selection can be changed. (For how to select a target surface, refer to “4.1.4 Target surface TIN selection view.”)



### ■ Changing offset settings of target surface

The target surface will move up and down by the set offset value.



1. Select the offset direction.  
“Vertical”: Offset in the vertical direction  
“Perpendicular”: Offset perpendicular to the target surface

2. Set the offset distance.

The target surface will be offset by the value entered to “Offset Distance.” Tap  to reset the entered value.



By entering a value to  $\Delta$ , the offset distance will be increased or decreased by the entered value when

 is tapped. This operation is also possible by tapping  on the guidance main screen.

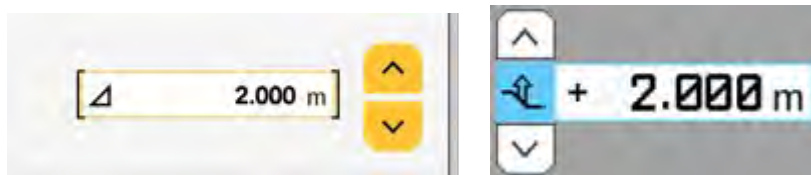

The offset target surface is displayed as a green line on the guidance screen.

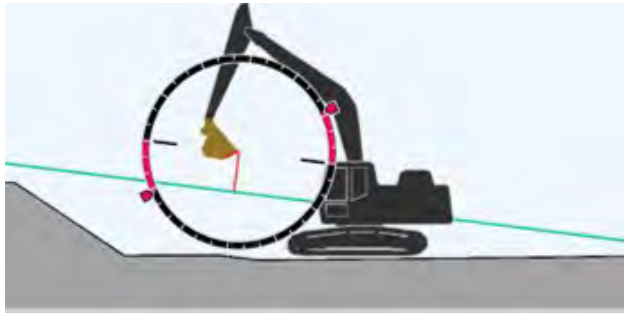

3. Tap “✓” to reflect the settings.

### ■ Changing the maximum slope change of target surface

In the target surface TIN selection view, the range to be selected as the target surface can be set.

1. Enter the slope change to be set as the target surface to “Max Grade Transition.”

This can also be set by specifying the amount of change at  $\Delta$  and tapping .

In the target surface TIN selection view, the design surface with a slope less than the maximum slope change value and adjacent to the TIN on the selected icon can be set as the target surface.

2. Tap “✓” to reflect the settings.

---

## 4.2.3 Changing facing angle compass and sound settings

---

1. Tap “Compass and Sound Settings” on the “Guidance Settings” screen to open the “Compass and Sound Settings” screen.  
The current settings are displayed.

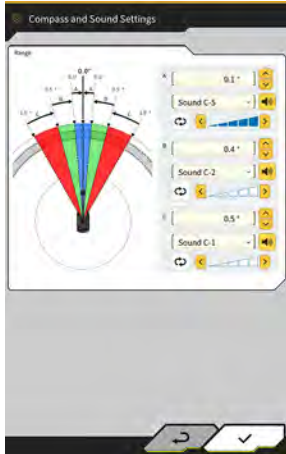

2. Change the settings according to the following:
  - Set the A, B, and C ranges.
  - Select a sound type from 30 options. You can hear the sound by tapping the speaker button.
  - The sound volume can be set in five steps.

### Supplementary explanation

- Animation is displayed while hearing the sound.
3. Tap “✓.”  
The changes will be reflected and the display will return to the previous screen.

## 4.2.4 Changing heat map and sound settings

The heat map display and beep sound can be set according to the distance from the cutting edge to the target surface.

1. Tap “Heatmap and Sound Settings” on the “Guidance Settings” screen to open the “Heatmap and Sound Settings” screen.  
The current settings are displayed.

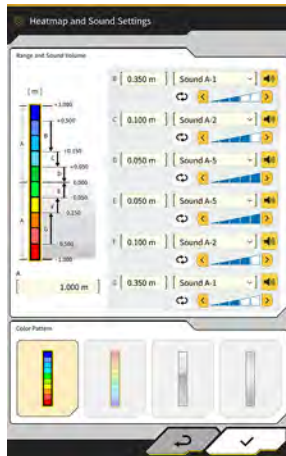

2. Change the settings according to the following:
  - By entering values of “Range and Sound Volume”, the range of the heat map display can be changed.

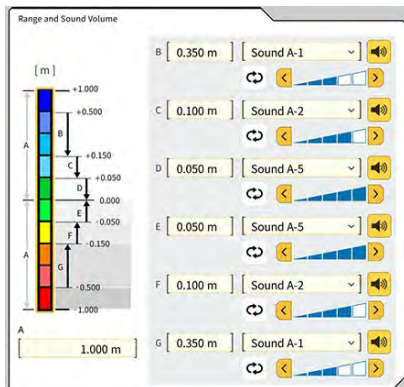

- By tapping on the rectangle of the heat map in “Range and Sound Volume”, colors can be specified one by one.

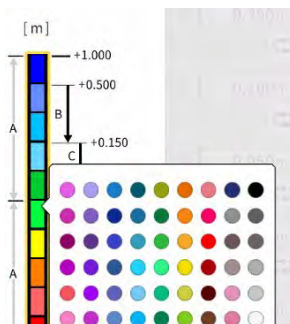

- From “Color Pattern,” four patterns of heat maps prepared in advance can be selected.



- By tapping  in “Range and Sound Volume”, the volume of the sound generated when the distance set in the heat map is approached can be set in five steps. A sound can be selected from 30 options, and you can hear it by tapping the speaker button.

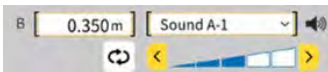

### Supplementary explanation

- Animation is displayed while hearing the sound.

## 4.2.5 Changing application settings

1. Tap “Application Settings” on the “Guidance Settings” screen to open the “Application Settings” screen. The current settings of Smart Constriction Pilot are displayed.

| Category            | Name                          | Function  |
|---------------------|-------------------------------|---|
| Display Mode        | Heatmap                       | Enables/disables the heat map display.  |
|                     | Distance Direction            | Switches the calculation method of the distance from the cutting edge to the design surface between “Vertical” and “Perpendicular.” |
|                     | Target Surface Extension      | Enables/disables expansion of the target surface.   |
|                     | Light Bar Size                | Allows you to select a light bar size from “Large,” “Middle,” and “Small.” The default is “Large.”                                  |
|                     | Linework Thickness            | Allows you to select a line work display thickness from “Bold”, “Normal” and “Thin”. The default is “Normal”.                       |
|                     | Decimal Places                | Switches the effective accuracy when displaying the distance from the bucket to the target surface.<br>The default is two digits.   |
|                     | Display Machine               | Enables/disables the machine display.   |
|                     | Display Name of Control Point | Enables/disables the reference point name display.  |
|                     | Bucket Wire Frame Mode        | Displays on/off of the function to display the bucket in wire frame.  |
| Profile View Screen | Profile Display Value         | Switches between “Angle” and “Distance” for the profile display.  |
|                     | Rotation Mode                 | Enables/disables the display with the machine pitch fixed with the viewpoint on the operator’s lateral side.                        |
|                     | Focus Point                   | Switches the center of the guidance screen between “Cutting Edge” and “Body Center.”  |

| Category               | Name                          | Function   |
|------------------------|-------------------------------|--|
| Section View Screen    | Section Display Value         | Switches between “Angle” and “Distance” for the section display.   |
|                        | Rotation Mode                 | Enables/disables the display with the machine pitch fixed.   |
|                        | Section View Distance Setting | Enables/disables the display of the distance to the design surface.  |
|                        | Elevation                     | Enables/disables the display of the elevations of both ends of the bucket cutting edge.                              |
| Plan View Screen       | Plan Display Value            | Switches between “Angle” and “Distance” for the plan display.  |
|                        | Bucket Width Line             | Enables/disables the display of the bucket width line with the sky viewpoint.  |
| Bucket Bottom As-build | Bottom Mode                   | Enables/disables the function to update the construction history with the coordinates of the bucket bottom.          |
| Steer Indicator        | Steer Indicator Mode          | Enables/disables the steer indicator function.   |
|                        | Display Mode                  | Switches the steer indicator display position for the two-split screen display between “Bottom” and “Middle.”        |
| Extended Function      | Extension Arm Function        | Enables/disables the extension arm function.   |
|                        | Tilt Bucket Function          | Enables/disables the tilt bucket function.   |
| Extended Model         | 2 Piece Boom Function         | Enables/disables the two-piece boom function.  |
|                        | Swing Boom Function           | Enables/disables the swing boom function.  |
|                        | Offset Boom Function          | Enables/disables the offset boom function.   |
| Others                 | Maximum Baseline              | Allows you to set the effective distance for the caution displayed when getting too far away from the control point. |

### Supplementary explanation

- You can also open the “Application Settings” screen by tapping “Application Settings” in the payload meter menu.
- Change the settings and tap “✓.” The changes will be reflected and the display will return to the guidance screen.

---

## 4.2.6 Changing guidance color settings

---

1. Tap “Guidance Color Settings” on the “Guidance Settings” screen to open the “Guidance Color Settings” screen.



2. When you want to set the colors of “TIN,” “Side,” etc. separately, tap the color of each item in “Color Settings” to display a color palette and specify the color.



3. To use a preset color combination, specify the pattern in “Color Pattern.”
4. Tap “✓” to save the guidance color settings.

# 5. Customization

## 5.1 Changing GNSS settings

The “GNSS Settings” screen allows you to select the following functions in the menu.

|                     |   |
|---------------------|---|
| GNSS Basic Settings | Displays the GNSS basic settings.   |
| Ntrip Settings      | Allows you to check the Ntrip settings.   |
| GNSS Info           | Displays the GNSS information including the status and the number of captured satellites. |

1. Tap  to open a menu.



2. Tap “GNSS Settings.”





---

## 5.1.1 Checking or changing GNSS settings

---

1. Tap “GNSS Basic Settings” on the “GNSS Settings” screen.



2. Set up by referring to the following:
  - Change the GNSS settings.  
Edit each item and then tap “✓.”  
The changes will be reflected and the display will return to the previous screen.
  - Reset the satellite correction information within the GNSS receiver.  
Tap “Soft Reset.”  
If it is successful, the display will return to the previous screen.
  - Reset the satellite correction information within the GNSS receiver and reacquire the orbit (ephemeris) of each satellite.  
Tap “Hard Reset.”  
If it is successful, the display will return to the previous screen.

### Supplementary explanation

- “FIX duration time” is displayed when the firmware version of the GNSS controller is v1.7.0 or later.

## 5.1.2 Changing Ntrip settings

Ntrip, an acronym for “Networked Transport of RTCM via Internet Protocol”, is a protocol for distributing differential GPS (DGPS) data over the Internet. Note that the contents to be entered vary depending on the service used.

1. Tap “Ntrip Settings” on the “GNSS Settings” screen.  
The Ntrip caster server authentication information and connection status logs are displayed.



2. Set up by referring to the following:
  - By tapping , the mount point will be acquired from the Ntrip caster.
  - The mount point name can be entered manually.
3. Tap “✓” to start Ntrip connection.

### Notice

- The default setting of the Ntrip client version is “Ver2.” When not fixed, change the setting of the Ntrip client version to “Ver1.”

## 5.1.3 Checking GNSS information

1. Tap “GNSS Info” on the “GNSS Settings” screen.  
The list of GNSS information is displayed.

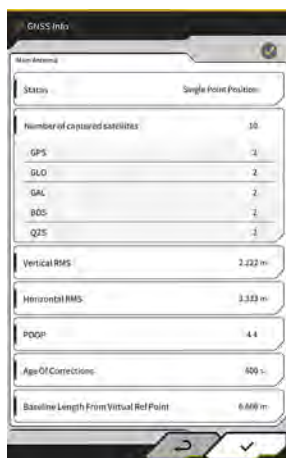

Confirm that “Vertical RMS” and “Horizontal RMS” of “Main Antenna” are 0.02 or less. If they are not less than or equal to 0.02, wait until the satellite reception is in good condition and then check again.

---

---

### **Supplementary explanation**

- When you use the GNSS controller with a firmware version of v1.4.3 or earlier, each item under “Number of captured satellites” shows “-.”
2. Tap “✓.” The previous screen will be displayed.

## 5.2 Changing bucket configuration

The following functions can be selected via the bucket file settings screen.

|                          |   |
|--------------------------|---|
| Bucket file download     | A bucket file is selected from the list of the bucket files registered in the Smart Construction server or controller and downloaded to the tablet terminal.<br>Also, a bucket file saved in the controller can be deleted. |
| Bucket calibration       | After replacing the bucket, perform a calibration before registering new one on the tablet.<br>This work is unnecessary if the calibration is performed during the installation of the Kit.                                 |
| Bucket file setting      | A bucket file to use is selected from the bucket files saved on the tablet terminal and uploaded to the controller.   |
| Bucket tooth calibration | Perform a calibration to reflect the worn bucket tooth length to the Machine Guidance.  |

1. Tap  to open a menu.



2. Tap "Bucket Configuration" to open the bucket file settings screen.

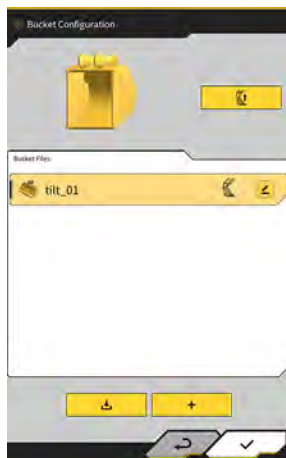

## Notice

- When you want to use a tilt bucket, update the firmware of the GNSS controller and the tablet application to v1.5.7 or later and v1.0.04 or later, respectively.
- When using a tilt bucket, set "Tilt Bucket Function" to "ON" on the "Application Settings" screen.

### Supplementary explanation

- This system does not support buckets with a rotary mechanism.
- With multicoupler installed, perform a calibration of the bucket shape including the multicoupler.
- You can also open the bucket file settings screen by tapping "Bucket Configuration" in the payload meter menu.

## 5.2.1 Downloading bucket file

1. Tap  on the bucket file settings screen.  
The information about the buckets registered in the Smart Construction server or controller will be displayed.

### Supplementary explanation

- To delete a bucket file registered in the controller, tap to select a deletion target bucket file from those under "Controller" and then tap .



2. Select a bucket file and tap .
  - Downloading the bucket file registered in the Smart Construction server  
Tap the bucket file to download from "Server."
  - Downloading the bucket file registered in the controller  
Tap the bucket file to download from "Controller."
3. Tap "✓."  
If a bucket file with the same file name as the file to be downloaded is saved on the tablet terminal, a confirmation window will be displayed.  
The bucket file is saved on the tablet terminal, and the display returns to the previous screen.

---

## 5.2.2 Bucket calibration

---

After replacing the bucket, perform a calibration before registering new one on the tablet. This work is unnecessary if the calibration is performed during the installation of the Kit.

### Notice

- The accuracy of the cutting edge may be reduced if the tilt angle is too large. After performing a calibration of the tilt bucket, check the accuracy of the cutting edge. For details, refer to “3.10 Checking cutting edge position accuracy.”

### Supplementary explanation

- This system does not support rotational buckets with a rotary mechanism.
- With multicoupler installed, be careful of the measurement position at the time of calibration. Perform measurement of the bucket shape including the multicoupler.

The bucket is calibrated by operating the tablet terminal. Measure the bucket shape and enter the values on the tablet terminal.

### ■ Checking measurement points

A standard, slope, and tilt buckets can be used.

1. Tap  on the bucket file settings screen to open the “Bucket Calibration” screen.
2. Select the bucket to calibrate and tap “→” at the bottom right of the screen.



3. Check the measurement points of the standard, slope, or tilt bucket.

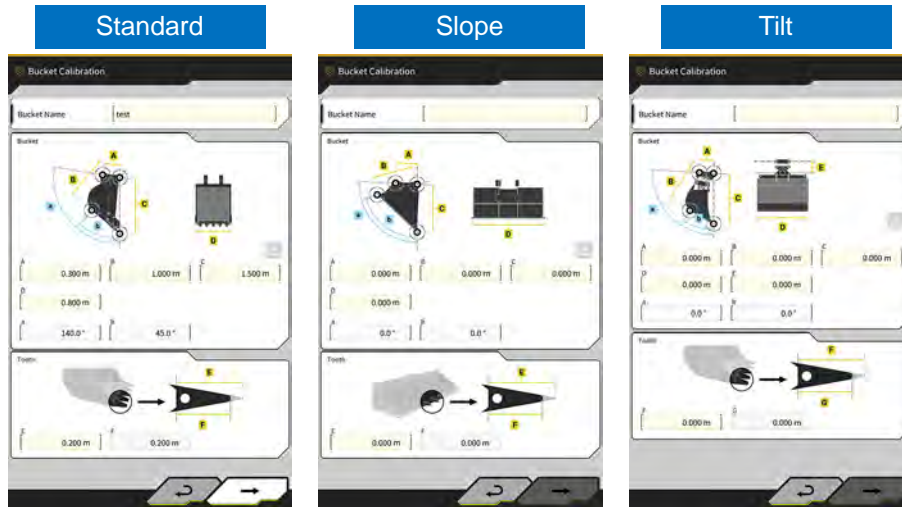

### ■ Measuring bucket shape

The following shows the measurement method using a standard bucket as an example.

In order to register the bucket information, measure the dimensions and angles of the bucket. Measure the dimensions and angles in increments of 0.001 meters and 0.1 degrees, respectively.

1. Move the Kit-equipped machine onto the flat and hard ground (slope angle: within five degrees), such as on a concrete surface.
2. Measure the dimension ① (B). The dimension ① (B) indicates the distance between the bucket pin ⑦ and the bucket link pin ⑧. Measure it using a measuring tape and enter the value.

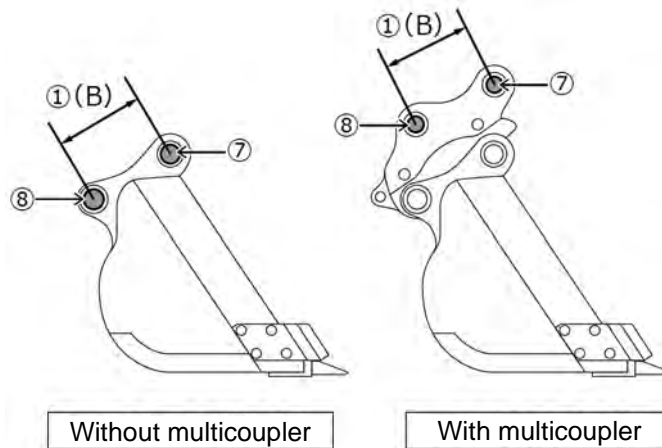

3. Measure the dimension ②. The dimension ② indicates the distance between the bucket pin and the cutting edge.  
Measure it using a measuring tape and enter the value. Perform the measurement by two people.

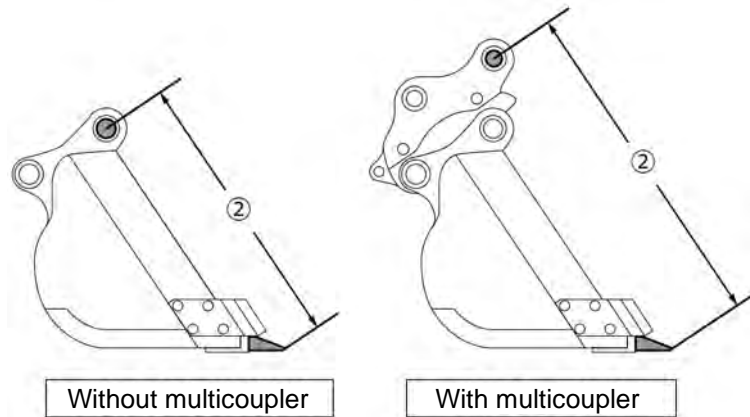

4. Measure the dimension ③ (A). The dimension ③ (A) indicates the distance between the lower edges of the bucket side cutters.  
Measure it using a measuring tape and enter the value. For buckets without side cutters, measure and enter the dimension of the widest part of the bucket.

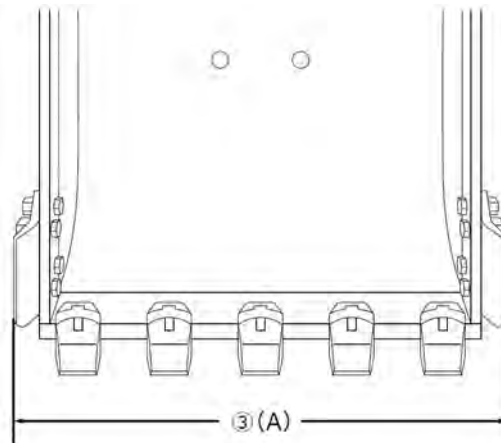

5. Measure the dimension ④ (F). The dimension ④ (F) indicates the distance between the root of the tooth and the cutting edge.  
Measure it using a measuring tape and enter the value.

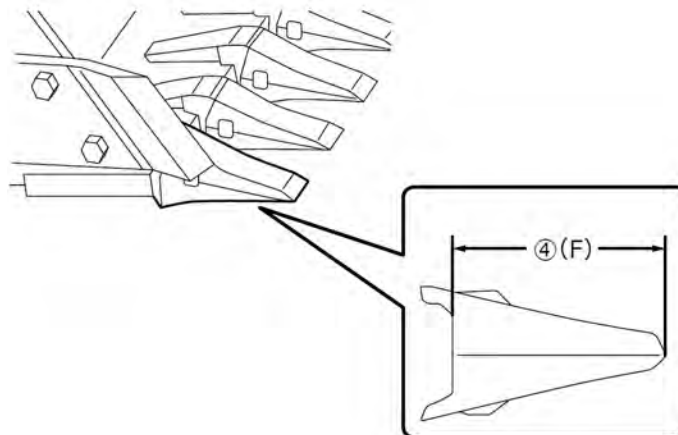



For buckets without teeth, measure and enter the blade width ⑨ (G).

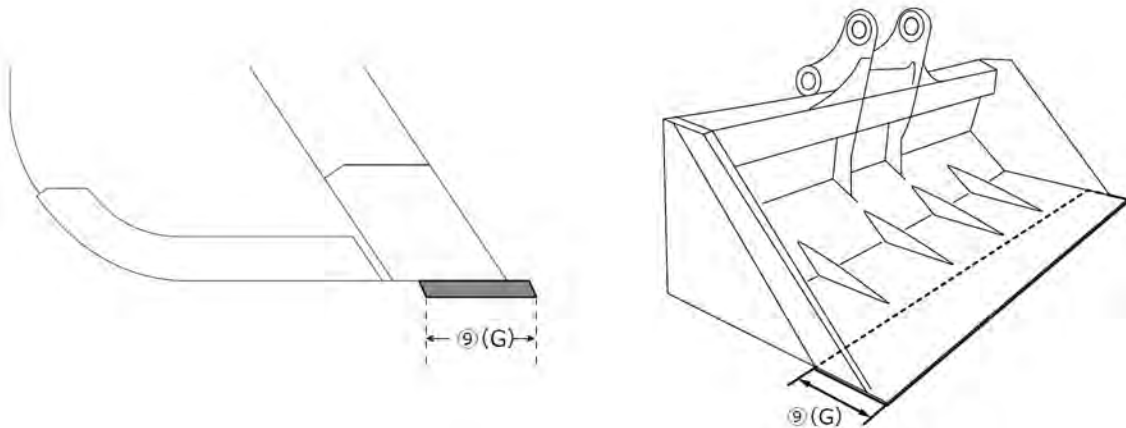

6. Measure the dimensions and angles of the bucket contour points.

- ⑤ (E): Angle of bucket contour point (i)
- ⑥ (C): Dimension of bucket contour point (i)
- ⑭ (D): Angle of bucket contour point (ii)

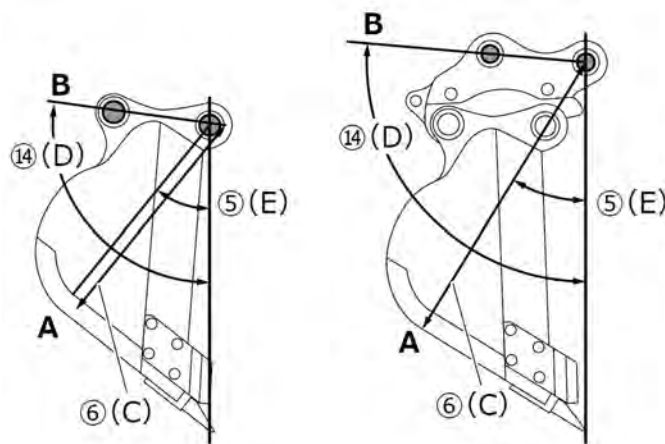

The two angles ⑤ (E) and ⑭ (D) can be measured without using digital spirit level.

Entering the length of ⑭ (D) activates the edit button.

Place the machine on stable ground and tap the update button to measure.

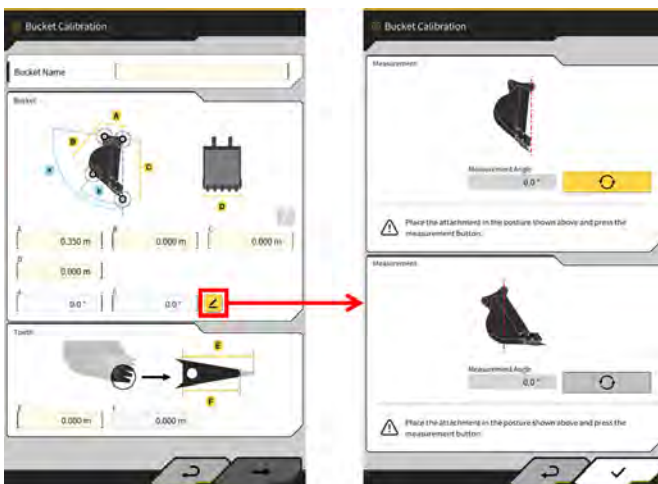

7. Mark the two bucket contour points (i) and (ii) with a marking pen. The bucket contour point (i) is the intersection of the straight part at the bottom of the bucket and the corner part. The bucket contour point (ii) is the outermost part on an extension of a straight line connecting the bucket pins and the bucket link pins.

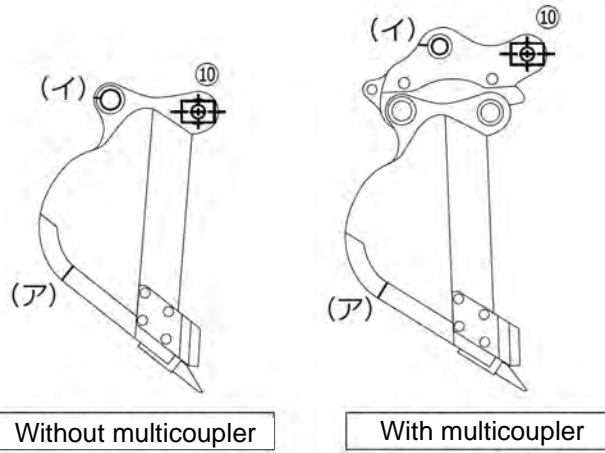

In the case that distinguishing the straight part at the bottom and the corner part is difficult, the point at which the bucket is assumed to touch the ground during ground digging is set to the bucket contour point (i).

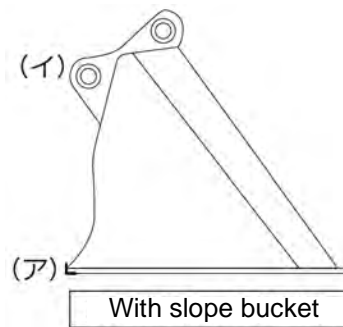

8. Install the magnet pole jig ⑩ to the bucket pin. At this time, the center of the foot pin and the center of the pole should be aligned.

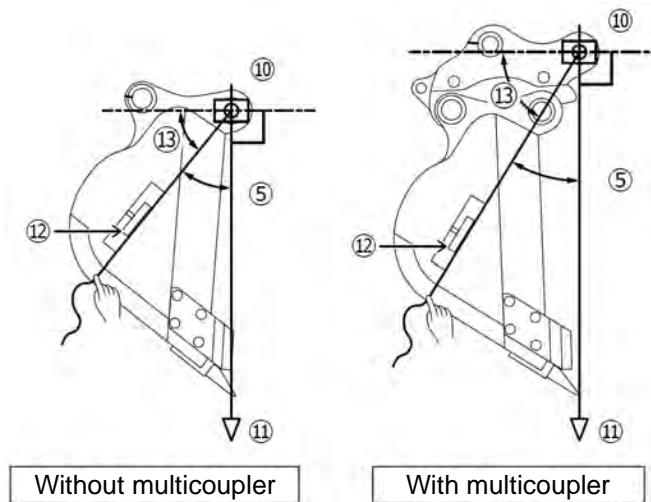

9. Hang a plumb bob ⑪ from the magnetic pole jig ⑩ and set up so that the line from the bucket pin to the cutting edge becomes vertical.
10. Measure the distance between the point (i) and the center of the pole with a measuring tape, and enter the value as the dimension ⑥.
11. Attach a string to the magnetic pole jig ⑩ and stretch the string to the measurement target points (i) and (ii).
12. On the string, set the digital angle meter ⑫ and measure the angle ⑬ of the points (i) and (ii) from the horizontal line of the bucket pin.
  - If the string is below the horizontal line of the bucket pin, enter the values obtained by subtracting the angle ⑬ from 90 ° for the angles ⑮ and ⑯ of the bucket contour points.
  - If the string is above the horizontal line of the bucket pin, enter the values obtained by adding the angle ⑬ to 90 ° for the angles ⑮ and ⑯ of the bucket contour points.

### Supplementary explanation

- Perform the measurement of the dimension ⑥ and the angles ⑮ and ⑯ of the bucket contour points by two people.
- When the work equipment is in the air, the work equipment descends by natural lowering.
- When measuring the bucket contour points, carry it out while checking the verticality with the plumb bob ⑪.

## ■ Bucket file calibration

Enter the measured values representing the bucket shape on the “Bucket Calibration” screen.

|                  |                                   |
|------------------|-----------------------------------|
| A                | Dimension ①                       |
| B                | Dimension ⑥                       |
| C                | Dimension ②                       |
| D                | Dimension ③                       |
| a                | Angle ⑭                           |
| b                | Angle ⑤                           |
| E                | Initial value of dimension ④ or ⑨ |
| F (*1)           | Current value of dimension ④ or ⑨ |
| Bucket name (*2) | Optional (“Bucket1,” etc.)        |

\*1: A value cannot be entered to F in this step.

It can be entered only when performing a bucket tooth calibration.

\*2: Set a bucket name that is unique and not the same as any of those used within the same company.

Check the entered values and then tap “→” if there is no problem. The entered bucket information will be saved on the tablet terminal, and the “Bucket Weight Settings” screen will be displayed.

## ■ Setting bucket weight and coupler

1. Set the bucket weight, use of coupler, and coupler weight.



## Notice

- The contents set on the “Bucket Weight Settings“ screen are used only with the payload meter functions.
- When you attempt to use the payload meter functions without setting the bucket weight, the following message will appear.



- Set the bucket weight and then perform an unloaded calibration.

2. Tap “✓.”

### ■ Setting tilt bucket IMU installation direction and measuring link angle

1. When using a tilt bucket, set the bucket weight and coupler and then set the tilt bucket IMU installation location and direction.



| Installation direction | Label                  | Connector             |
|------------------------|------------------------|-----------------------|
| 1                      | Top side of machine    | Left side of machine  |
| 2                      | Top side of machine    | Right side of machine |
| 3                      | Front side of machine  | Left side of machine  |
| 4                      | Front side of machine  | Right side of machine |
| 5                      | Bottom side of machine | Left side of machine  |
| 6                      | Bottom side of machine | Right side of machine |
| 7                      | Rear side of machine   | Left side of machine  |
| 8                      | Rear side of machine   | Right side of machine |

## Notice

- The IMU part number (setting) varies by the installation direction. Select the part number corresponding to the installation direction.

| Installation direction | Part number  |
|------------------------|--------------|
| 1, 2, 5, 6             | 2AB-06-11250 |
| 3, 4, 7, 8             | 2AB-06-11260 |

2. Tap “→.”
3. Operate the bucket following the screen instructions and tap  to acquire the IMU value.

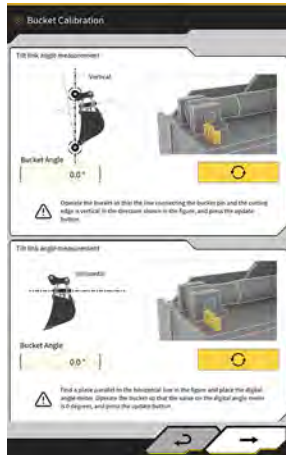

## Notice

- Use a digital angle meter in operating the bucket.

4. Tap “→.”
5. Operate the bucket following the screen instructions and tap  to acquire the IMU value.



6. Tap “✓” to save the acquired value.

---

## 5.2.3 Selecting bucket

---

1. On the bucket file settings screen, tap the bucket file to use from the list of the bucket files saved on the tablet terminal.
2. By tapping  and then tapping “✓” in the confirmation window, the selected bucket will be put into the “in use” state.

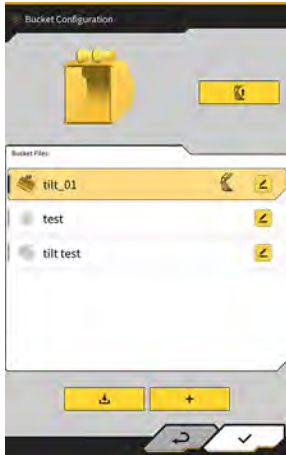

---

## 5.2.4 Calibrating bucket tooth

---

As wear of bucket tooth affects the accuracy of the cutting edge, perform a calibration for the wear amount.

1. Tap  of the target bucket file on the bucket file settings screen to open the “Bucket Tooth Calibration” screen.

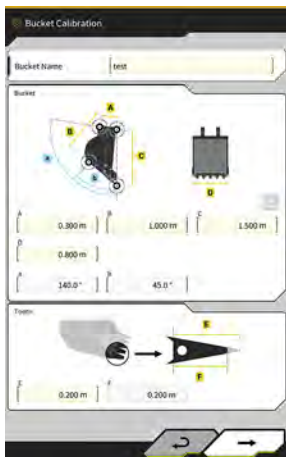

2. Enter the current tooth length to “F.”
3. By tapping “✓” at the bottom right of the screen, the entered content will be reflected, and the display will return to the main screen.

## 5.3 Changing machine calibration settings

The “Machine Calibration Settings” screen allows you to select the following functions in the menu.

|                          |   |
|--------------------------|---|
| Machine Calibration      | Performs calibration of the Kit-equipped machine.   |
| Swing Sensor Calibration | Performs calibration of the swing boom models.  |
| Individual Calibrations  | Performs calibration of the work equipment without using TS (Total Station).                            |
| 2D/3D Accuracy Check     | Checks the pin coordinates, angle, and distance from the boom foot in real time for the work equipment. |
| Machine Calibration Info | Displays the list of calibration information about the Kit-equipped machine.                            |
| Position Posture Info    | Displays the information about the position and posture of the Kit-equipped machine.                    |

1. Tap  to open a menu.



2. Tap “Machine Calibration Settings.”





### Supplementary explanation

- You can also open the “Machine Calibration Settings” screen by tapping “Machine Calibration Settings” in the payload meter menu.

## 5.3.1 Performing machine calibration

Tap “Machine Calibration” on the “Machine Calibration Settings” screen.

For the details, refer to the Instructions for Installation. The distribution destination of the Instructions for Installation, the ID, and the password are found on the paper included with the product.

For the two-piece boom and offset boom specifications, the machine calibration needs to be performed with an additional sensor installed.

### Notice

- When performing the machine calibration for the two-piece boom specification, set “2 Piece Boom Function” to “ON” on the “Application Settings” screen and set “Enable” of “2nd Boom IMU” to “ON” on the “Controller Settings” screen.
- When performing the machine calibration for the offset boom specification, set “Offset Boom Function” to “ON” on the “Application Settings” screen and set “Enable” of “Offset Sensor” to “ON” on the “Controller Settings” screen.

### 5.3.1.1 Performing machine calibration for standard specification

Perform the calibration following the screen instructions.



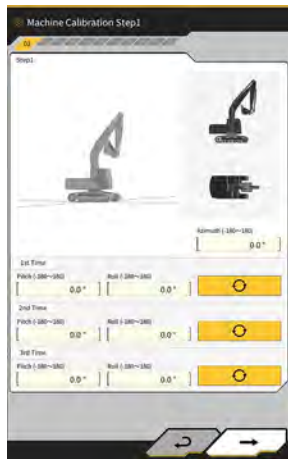





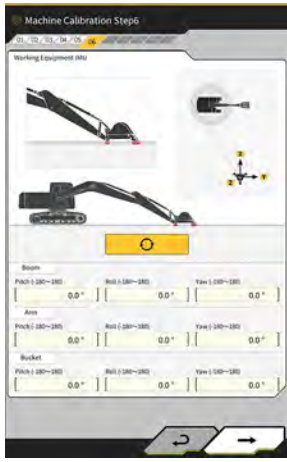
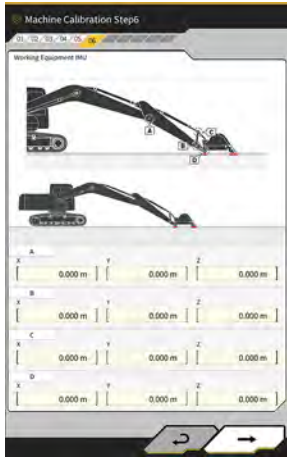
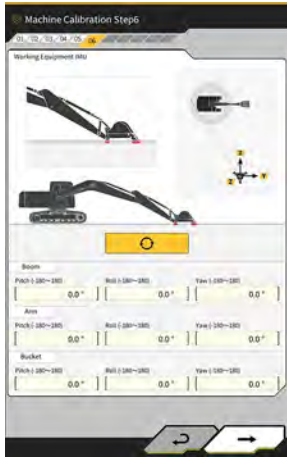

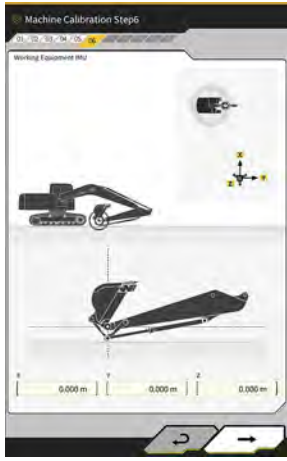

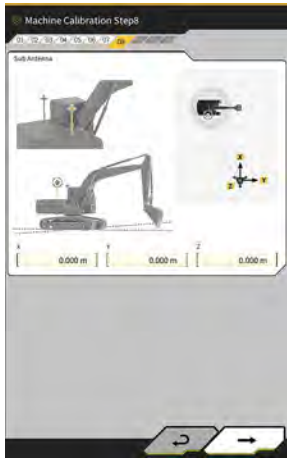





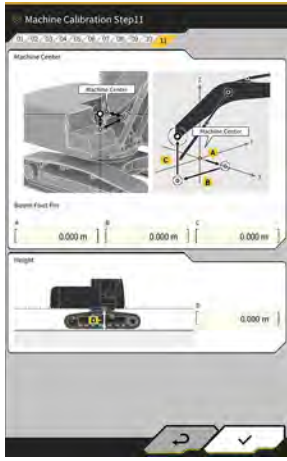

### 5.3.1.2 Performing machine calibration for offset specification

#### Notice

- For how to install the offset boom sensor, etc., refer to the separate manual.
- As of 2024/4, kit for offset specification machine is only available in Japan.

#### ■ Preparation

Prepare the following equipment.

- Set of Smart Construction 3D Machine Guidance Kit (including tablet terminal and Wi-Fi router)
- Total station (TS)
- Calibration jigs dedicated for Komatsu ICT excavator or general-purpose items (prism)
- Set of cutting edge measuring jigs

Update the firmware of the GNSS controller and the tablet application to v2.0.3 or later and v.1.0.06.2 or later, respectively.

1. Since the extending and raising operations to the maximum level and swinging operation are required, move the construction machine to an open space.
2. Locate the construction machine on a level (if possible) and hard ground, such as on a concrete surface, on which the machine body is not supported in a seesaw state.
3. Reciprocate each part of the hydraulic circuit to the stroke end to prevent the inside of the cylinder from being put into the vacuum state.
4. In order to minimize natural lowering, increase the hydraulic oil temperature until the adequate temperature display is provided.
5. On the start-up screen, tap "Machine Guidance" to open the Machine Guidance screen.
6. Tap  to open a menu.
7. Tap "Guidance Settings" → "Application Settings" and set "Offset Boom Function" to "ON" and then tap "✓" at the bottom right of the screen.

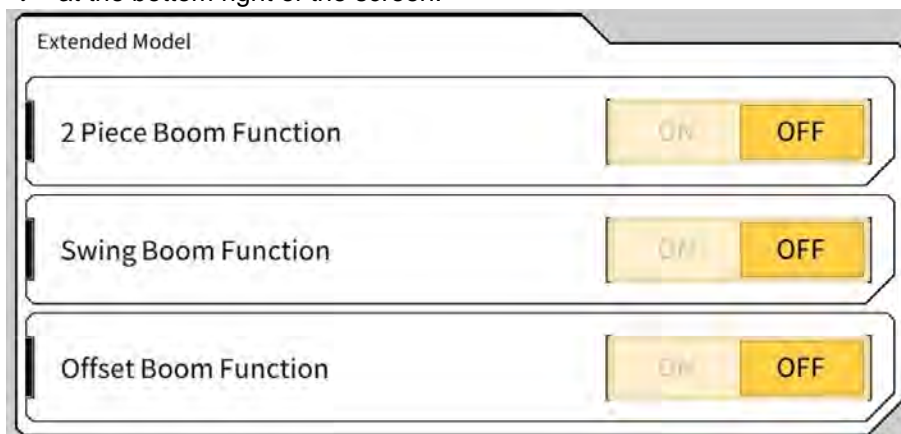

8. Tap  → "Administrator Settings" (enter administrator password) → "Controller Settings" and change "Enable" of "Offset Sensor" to "ON" and then tap "✓" at the bottom right of the screen.

#### ■ Performing machine calibration

Basically, this is the same as the machine calibration for the standard specification. There are additional measurement points specific to the offset boom models. The following describes only the points changed from the standard specification.

The machine calibration for the offset boom models requires the installation of a prism to the following three locations (① to ③) and measurement with TS.  
When performing measurement with TS, adjust the prism so that it comes to the axial center.

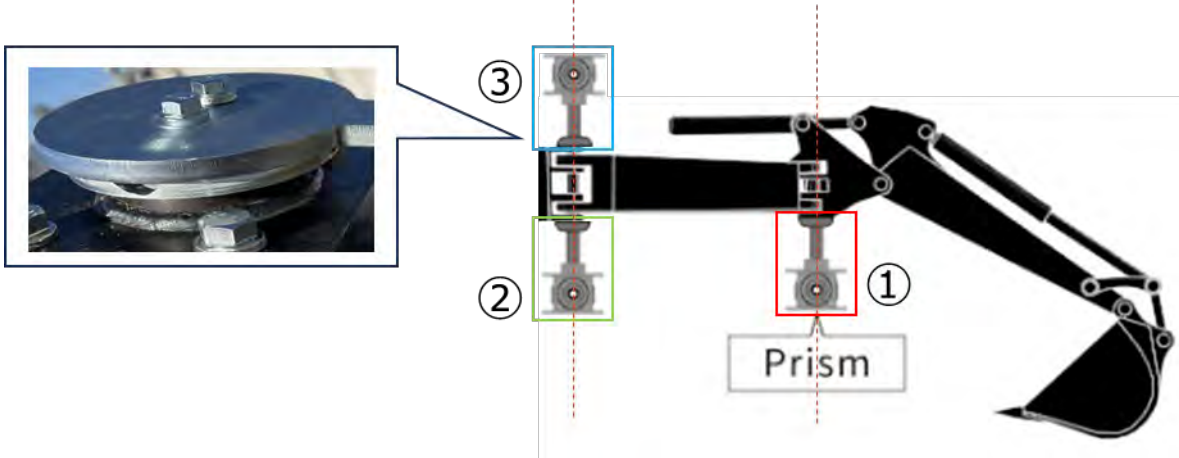

### Notice

- Install a prism to each measurement point and perform measurement.
    - \* You do not need to prepare three prisms.
    - \* After the offset sensor is installed, a bolt exists in the location ③.
- When installing a prism with a magnet, take a measure such as removing the sensor temporarily.

1. Tap  → “Machine Calibration Settings” → “Machine Calibration” and enter A as a password.
2. Enter values and perform measurement following the screen instructions.
3. In the step 4, check that the work equipment is in the neutral (not offset) state.
  - \* For the following machine calibration procedure, perform measurement without offsetting the work equipment.



4. In the step 6, install a prism to the locations E, F, and G in the figure matching the axial center and then perform measurement with TS.
- \*1: Do not change the prism height A in measuring E, F, and G.
  - \*2: There is no problem even if the prism height differs from the value obtained in the antenna measurement.

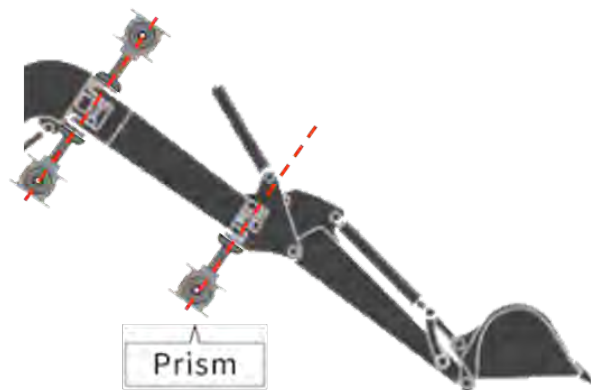
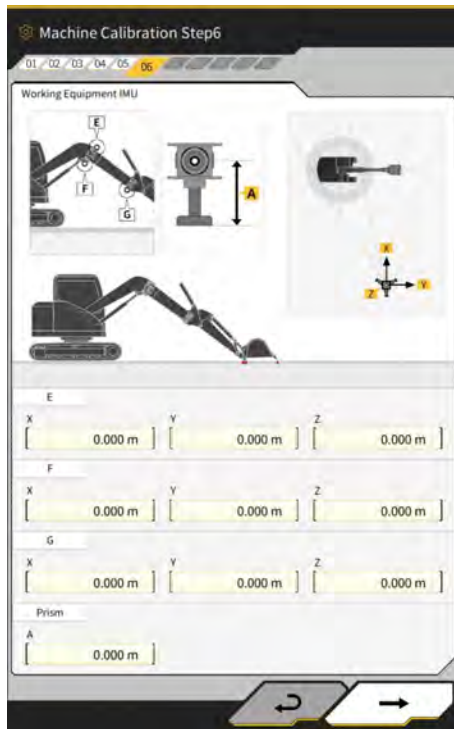

Install prisms to the axial center

5. Likewise, in the step 7, install a prism to the locations E, F, and G in the figure matching the axial center and then perform measurement with TS.
- \* Do not change the prism height from the value in the step 6 in measuring E, F, and G.

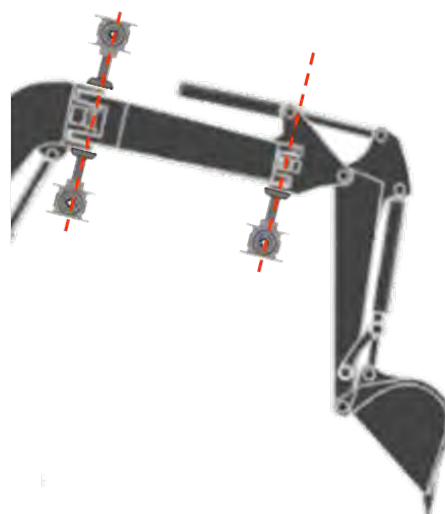

Install prisms to the axial center

6. Enter values and perform measurement following the screen instructions.
7. In the step 11, enter the following setting values according to the model.

| Model    | A     | B      | C     | D     |
|----------|-------|--------|-------|-------|
| PC58UU-6 | 0.063 | -0.160 | 0.413 | 0.611 |

8. When you complete entering all the values and "Success" appears, the machine calibration is completed. Check that the display of the construction machine has been changed to that for the offset boom models on the Machine Guidance screen.

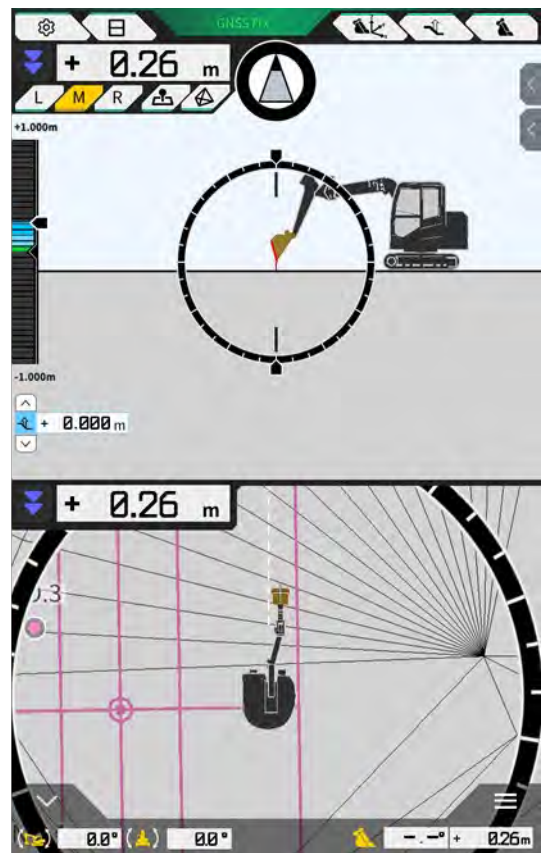

## ■ Performing offset sensor calibration

### Notice

- Perform the offset sensor calibration after the machine calibration is completed.
- When performing measurement with TS, adjust the work equipment so that the offset boom is leveled as much as possible. Do not move the work equipment. Perform offsetting only.
- Install TS to the position at which collimation is available when the work equipment is offset to both ends.

1. Tap  → “Machine Calibration Settings” → “Offset Sensor Calibration.”
2. Perform measurement and enter values following the screen instructions.
3. In the step 2, move the work equipment to the **neutral** position and stop it.
4. In the step 3, move the work equipment to the **right end** position and stop it.
5. In the step 4, move the work equipment to the **left end** position and stop it.
6. When the offset sensor calibration is completed successfully, “Success” will appear.  
If a measurement error of offset angle or TS is large or if an entered value is incorrect, “Failed” will appear.  
Perform measurement again or check if the entered values are correct.

### 5.3.2 Checking machine calibration information

Tap “Machine Calibration Info” on the “Machine Calibration Settings” screen. The list of current calibration information will be displayed.



#### Notice

- Each setting item can be changed; however, since changes cause the calibration setting value to change, usually do not make changes. If you need to make changes, refer to the Instructions for Installation. The distribution destination of the Instructions for Installation, the ID, and the password are found on the paper included with the product.

---

### 5.3.3 Checking position and posture of machine body

---

1. Tap “Position Posture Info” on the “Machine Calibration Settings” screen.  
Detailed information about the position and angle of the machine body is displayed.



2. Tap “✓.”  
The display will return to the guidance screen.

---

### 5.3.4 Swing sensor calibration

---

Calibrate the swing sensor to use the swing boom models.

#### Notice

- For how to install the swing boom sensor and link mechanism for swing, refer to the separate manual.
- Perform the swing sensor calibration after the machine calibration is completed.
- Perform the swing sensor calibration by two people.
- As of 2024/4, kit for swing specification machine is only available in Japan.

#### ■ Preparation

Prepare the following equipment.

- Set of Smart Construction 3D Machine Guidance Kit (including tablet terminal and Wi-Fi router)
- Total station (TS)
- Calibration jigs dedicated for Komatsu ICT excavator or general-purpose items (prism)
- Set of cutting edge measuring jigs

Update the firmware of the GNSS controller and the tablet application to v1.7.2 or later and v.1.0.04 or later, respectively.

1. Since the extending and raising operations to the maximum level and swinging operation are required, move the construction machine to an open space.
2. Locate the construction machine on a level (if possible) and hard ground, such as on a concrete surface, on which the machine body is not supported in a seesaw state.
3. Reciprocate each part of the hydraulic circuit to the stroke end to prevent the inside of the cylinder from being put into the vacuum state.
4. In order to minimize natural lowering, increase the hydraulic oil temperature until the adequate temperature display is provided.
5. On the start-up screen, tap “Machine Guidance” to open the Machine Guidance screen.
6. Tap  to open a menu.

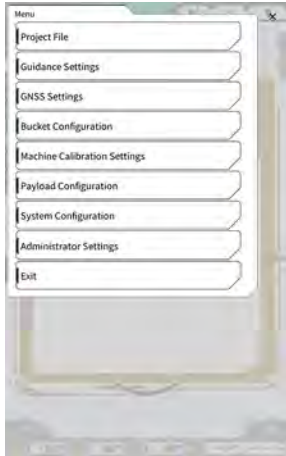

7. Tap "Guidance Settings" to open the "Guidance Settings" screen.



8. Tap "Application Settings" to open the "Application Settings" screen.



9. Set "Swing Boom Function" to "ON" and tap "✓."



10. Tap  to open a menu and then tap "Machine Calibration Settings."



11. Check that “Swing Sensor Calibration” is displayed on the “Machine Calibration Settings” screen.



12. Tap  to open a menu and then tap “Administrator Settings” to open the “Administrator Settings” screen.



13. Tap “Controller Settings” to open the “Controller Info” screen.



- Set "Enable" of "Swing Sensor" to "ON" and tap "✓."



## ■ Performing calibration

### Notice

- When performing measurement with total station (TS), set the work equipment in the most extended state. Perform swinging only without moving the work equipment in order not to change the distance from the center of swinging to a prism.

- Install a prism to the stable position at which collimation is available from TS when you swing the work equipment, such as the bottom of the bucket.

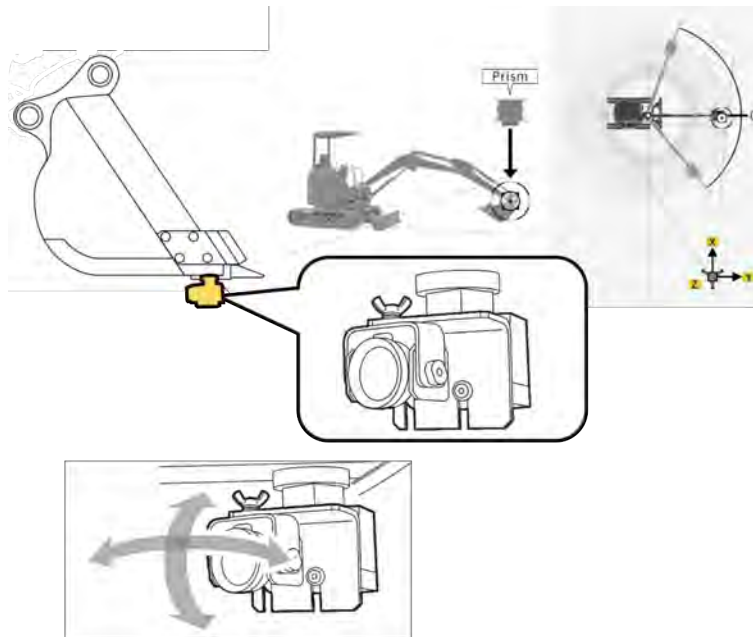

- Tap "Swing Sensor Calibration" on the "Machine Calibration Settings" screen to open the "Swing Sensor Calibration" screen.

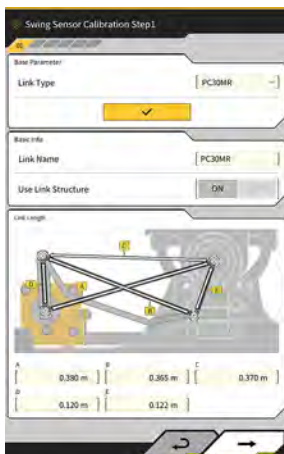

3. Select a link type at “Link Type” and tap “✓” to apply the parameters.
4. Tap “→” to proceed to the next step.

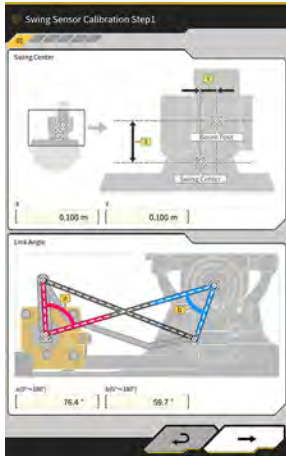

5. Check that the parameters are set for “Swing Center” and “Link Angle” and then tap “→” to proceed to the next step.



6. Move the work equipment to the neutral position and stop it.
7. Measure the prism coordinates with TS and enter the values to “Prism.”
8. Tap  and acquire the swing angle when the work equipment is set in the neutral state.
9. Check the acquired value and then tap “→” to proceed to the next step if there is no problem.

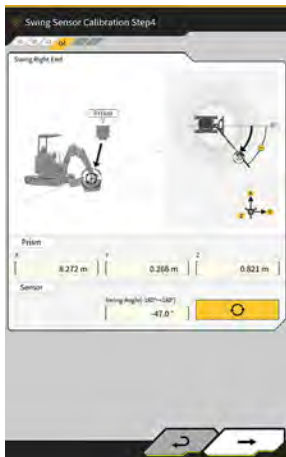

10. Move the work equipment to the right end position and stop it.
11. Measure the prism coordinates with TS and enter the values to “Prism.”

12. Tap  and acquire the swing angle when the work equipment is set in the right end position.
13. Check the acquired value and then tap “→” to proceed to the next step if there is no problem.



14. Move the work equipment to the left end position and stop it.
15. Measure the prism coordinates with TS and enter the values to “Prism.”
16. Tap  and acquire the swing angle when the work equipment is set in the left end position.
17. Check the acquired value and then tap “→” to proceed to the next step if there is no problem.



18. Tap any  displayed to open the measurement screen.





### Supplementary explanation

- You can tap any .

19. Swing the work equipment to match "Target Angle."
20. Measure the prism coordinates with TS and enter the values to "Prism."
21. Tap  and acquire the swing angle of the work equipment.
22. Check the acquired value and then tap "✓" if there is no problem.
23. Repeat the steps 20 to 24.

### Supplementary explanation

- When you want to add a measurement point, tap  and enter a target angle.
- When a frequently used swing angle is added as a measurement point, measurement can be performed accurately.

24. When  is displayed at all measurement points, tap "✓."

### Notice

- When the swing sensor calibration is completed successfully, "Success" will appear.
- If a measurement error of swing angle or TS is large or if an entered value is incorrect, "Failed" will appear. In this case, perform measurement again or check if the entered values are correct.

## 5.3.5 Individual calibration

Individual calibration is the function to calibrate the work equipment without using the total station (TS).

### Notice

- The individual calibration does not support the calibration of the antenna installation position.
- The individual calibration does not support the swing boom models and extension arm.

### ■ Preparation

Prepare the following equipment.

- Set of Smart Construction 3D Machine Guidance Kit (including tablet terminal and Wi-Fi router)
- Plumb bob
- Level gauge
- Measuring tape, steel scale
- Magnet

Update the tablet application to v.1.0.05 or later.

1. Locate the construction machine on a level (if possible) and hard ground, such as on a concrete surface, on which the machine body is not supported in a seesaw state.

### Supplementary explanation

- When using a two-piece boom, set "2 Piece Boom Function" to "ON" on the "Application Settings" screen.

## ■ Basic machine settings

1. Tap “Individual Calibrations” on the “Machine Calibration Settings” screen to open the “Individual Calibrations” screen.



2. Tap “Basic Machine Settings” to open the “Basic Machine Settings” screen.



3. Enter values to “Makes,” “Machine Name,” and “Machine ID” and then tap “→” to proceed to the next step.

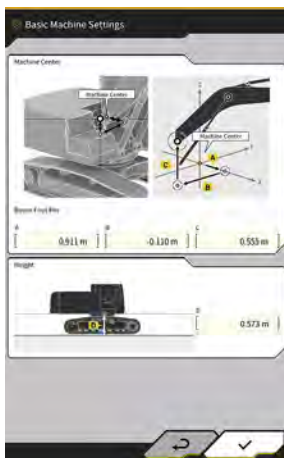

## Notice

- Enter correct data to “Machine Name” and “Machine ID.” They are used for the machine management on the server side.

4. Enter the design values of boom foot pin and the height from the machine center to the ground and then tap “✓” to complete the basic machine setting.

### Supplementary explanation

- When the basic machine settings are saved normally, “Success” will appear.

### Machine IMU calibration

1. Tap “Body IMU Calibration” on the “Individual Calibrations” screen to open the “Body IMU Calibration” screen.



2. Operate the upper rotary body and each cylinder of the work equipment to gain the posture displayed on the screen.
3. Tap  to measure IMU values from “1st Time” in order.
4. When you have finished measurements up to “3rd Time,” tap “→” to proceed to the next step.

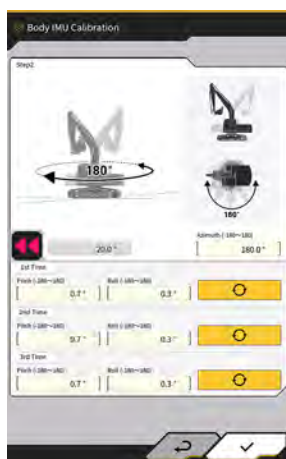

### Supplementary explanation

- When an error is displayed, perform measurement again.
5. Without changing the posture of the work equipment, swing the upper rotary body by 180 degrees while observing the angle at  and then stop it for about 10 seconds.

6. Tap  to measure IMU values again from “1st Time” in order.
7. When you have finished measurements up to “3rd Time,” tap “✓” to complete the machine IMU calibration.

### Supplementary explanation

- When an error is displayed, try again from the step 1.

### ■ Boom and IMU calibration

1. Tap “Boom and IMU Calibration” on the “Individual Calibrations” screen to open the “Boom and IMU Calibration” screen.

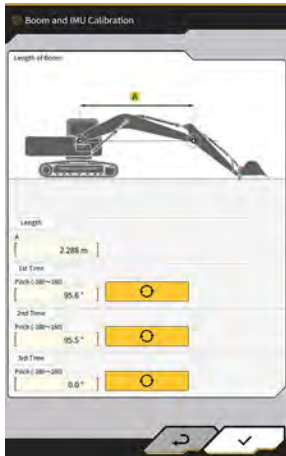

2. Operate the work equipment to gain the posture displayed on the screen.

### Notice

- For the standard models, operate the work equipment so that the boom foot pin and the boom top pin are leveled. Check the levelness using a level gauge.
- For the two-piece boom models, operate the work equipment so that the boom foot pin and the boom top pin are set vertically. Using a plumb bob, check that the boom top pin is positioned vertically.
- Ground the bucket to prevent natural lowering of the work equipment during measurement.

3. Enter a value to “Length” and then tap  to measure IMU values from “1st Time” in order.
4. When you have finished measurements up to “3rd Time,” tap “✓” to complete the boom and IMU calibration.

### ■ 2nd boom and IMU calibration

### Notice

- The 2nd boom and IMU calibration is performed only on the two-piece boom models.



1. Tap “2nd Boom and IMU Calibration” on the “Individual Calibrations” screen to open the “2nd Boom and IMU Calibration” screen.



2. Operate the work equipment to gain the posture displayed on the screen.

### Notice

- Operate the work equipment so that the boom top pin and the 2nd boom top pin are leveled. Check the levelness using a level gauge.
- Ground the bucket to prevent natural lowering of the work equipment during measurement.

3. Enter a value to “Length” and then tap  to measure IMU values from “1st Time” in order.
4. When you have finished measurements up to “3rd Time,” tap “✓” to complete the 2nd boom and IMU calibration.

### ■ Arm and IMU calibration

1. Tap “Arm and IMU Calibration” on the “Individual Calibrations” screen to open the “Arm and IMU Calibration” screen.

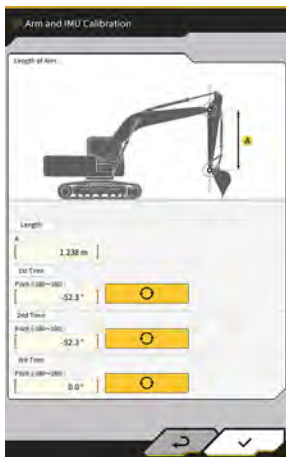

2. Operate the work equipment to gain the posture displayed on the screen.

### Notice

- Operate the work equipment so that the arm is set vertically. Using a plumb bob, check that the boom top pin or the 2nd boom top pin is positioned vertically.
- Ground the bucket to prevent natural lowering of the work equipment during measurement.

3. Enter a value to "Length" and then tap  to measure IMU values from "1st Time" in order.
4. When you have finished measurements up to "3rd Time," tap "✓" to complete the arm and IMU calibration.

### ■ Bucket link and IMU calibration

1. Tap "Bucket Link and IMU Calibration" on the "Individual Calibrations" screen to open the "Bucket Link and IMU Calibration" screen.



2. Operate the work equipment so that the bucket link is leveled with reference to the figure displayed on the screen.

## Notice

- Check the levelness of the bucket link using a level gauge.

3. Enter each link length to "Length" and then tap  to measure IMU values from "1st Time" in order.
4. When you have finished measurements up to "3rd Time," tap "✓" to complete the bucket link and IMU calibration.

## 5.3.6 2D/3D accuracy check

You can check the pin coordinates, angle, and distance from the boom foot in real time for the work equipment.

1. Tap "2D/3D Accuracy Check" on the "Machine Calibration Settings" screen to open the "2D/3D Accuracy Check" screen.



Standard/swing boom models



Two-piece boom models

| Display item |   | Standard/swing boom models                                 | Two-piece boom models                                       |
|--------------|---|--|---|
| A            |   | Coordinates of boom foot pin                               | Coordinates of 1st boom foot pin                            |
| B            |   | Coordinates of boom top pin                                | Coordinates of 1st boom top pin                             |
| C            |   | Coordinates of arm top pin                                 | Coordinates of 2nd boom top pin                             |
| Angle        | a | Boom angle   | 1st boom angle  |
|              | b | Arm angle  | 2nd boom angle  |
|              | c | Bucket angle   | -   |
| Distance     | D | Distance from the boom foot pin to the arm top pin         | -   |
|              | E | Distance from the boom foot pin to the bucket cutting edge | Distance from the 1st boom foot pin to the 2nd boom top pin |

### Supplementary explanation

- The displayed values are updated in real time.
2. For the two-piece boom models, tap “→” to open the next screen.



| Display item |   | Two-piece boom models  |
|--------------|---|--|
| A            |   | Coordinates of 1st boom foot pin                               |
| B            |   | Coordinates of 2nd boom top pin                                |
| C            |   | Coordinates of arm top pin                                     |
| Angle        | c | Arm angle  |
|              | d | Bucket angle   |
| Distance     | F | Distance from the 1st boom foot pin to the arm top pin         |
|              | G | Distance from the 1st boom foot pin to the bucket cutting edge |

3. Tap “✓.”

---

---

## 5.4 Changing calibration settings for extension arm



By tapping “Extension Arm Configuration,” the “Extension Arm Configuration” screen will be displayed. Extension arm files can be selected, downloaded, created, and edited in the same way as bucket files.



### 5.4.1 Selecting extension arm file

---

A list of extension arm files saved on the tablet terminal is displayed at the center of the screen.

1. By tapping on the target file, it will be highlighted.
2. Tapping  displays a confirmation window. Tap “✓” to select the target extension arm. To remove it, tap .
3. Tap “✓” at the bottom right of the screen. The changes will be reflected and the display will return to the previous screen.





---

## 5.4.2 Downloading extension arm file

---

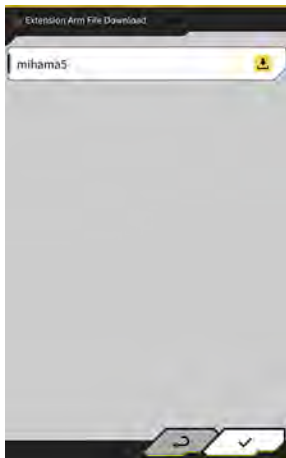
1. By tapping , a list of extension arm files saved in the server will be displayed.



2. Tapping  displays a confirmation window. Tap “✓” to download the target extension arm file.
3. Tap “✓” at the bottom right of the screen. The previous screen will be displayed.

## 5.4.3 Creating extension arm file

---

For the details, refer to the Instructions for Installation. The distribution destination of the Instructions for Installation, the ID, and the password are found on the paper included with the product.

### Notice

- Create an extension arm file after completing the machine calibration.

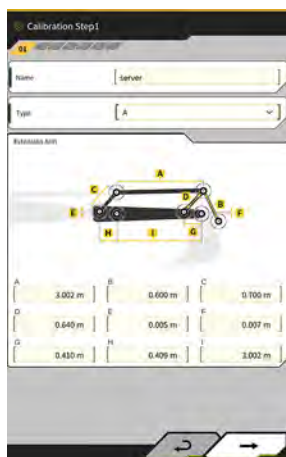





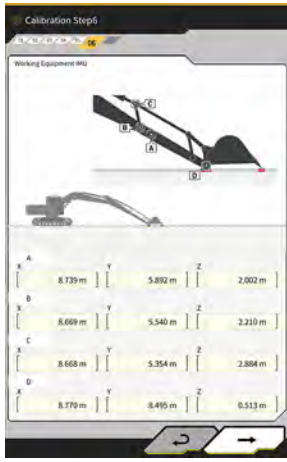
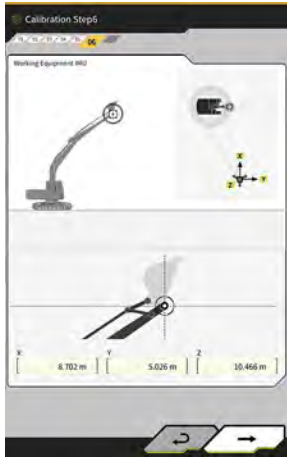



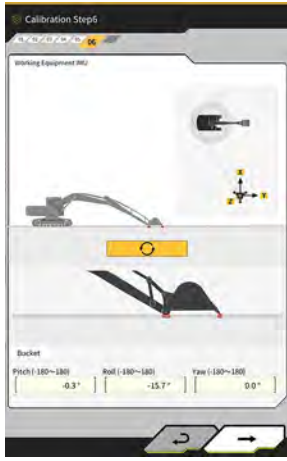

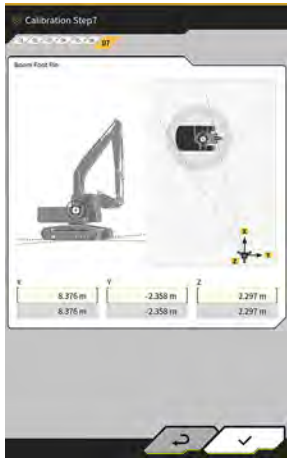
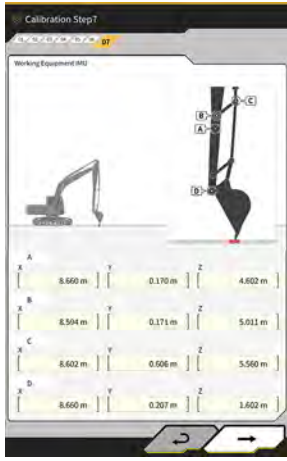



## 5.4.4 Editing extension arm file

Tap  at an extension arm file to change the setting items.

### Notice

- Each setting item can be changed; however, since changes cause the calibration setting value to change, usually do not make changes. If you need to make changes, refer to the Instructions for Installation.



## 5.5 Using geofence function

The geofence function places a 3D obstacle on the design data and issues an alert when the construction machine approaches or contacts with the obstacle. Using the geofence function, entering a hazard area, colliding with a structure, fence, etc., and contacting with a buried object or aerial cable can be avoided.

### Notice

- The contact detection and alert notification of the geofence function may not work properly depending on the use environment and conditions. Understand the function and use conditions, and use the geofence function without relying too much on it.
- The geofence function can be used on the construction machines with the 3DMG and standard specifications. It cannot be used on the construction machines with the 2DMG mode, simulator mode, two-piece boom, and swing boom specifications.
- The geofence function can be used with the tablet application of v1.0.04 or later.

### 5.5.1 Enabling function

1. Set “Geofence” to “ON” on the “Common Settings” screen.



2. Tap “✓.”

### 5.5.2 Setting geofence type

The following three types of geofence can be set.

- Wall type: Used to locate a building, fence, etc. This is a 3D object created by the coordinates of two points A and B, depth D, and height H. You can set “contact with construction machine (3D)” as an alert type.

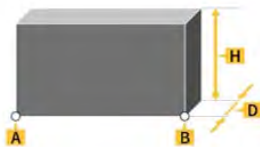

- Circle type: Used to locate a reference point, hazard area, etc. This is a 2D or 3D object created by the coordinates of a point A, radius R, and height H. You can set “contact with construction machine (3D)” or “entry/exit of construction machine to/from geofence (2D)” as an alert type.

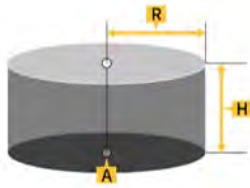

- Line type: Used to locate a water passage, electric wire, etc. This is a 3D object created by the coordinates of two points A and B, and radius R. You can set “contact with construction machine (3D)” as an alert type.



### Supplementary explanation

- The contents set for the geofence type are reflected to the parameters as default values. You can change each parameter in creating geofence.

### ■ Setting wall type

1. Tap  to open a menu.



2. Tap “Geofence Settings” to open the “Geofence Settings” screen.



3. Tap “Geofence Basic Settings” to open the “Geofence Basic Settings” screen.



4. Tap “Wall.”
5. Set “Thickness,” “Height,” “Alert Type,” etc.



### Supplementary explanation

- You can select an alert type from the five options: “Notice” (sound only), “Attention” (blinks in yellow with sound), “Caution” (blinks in yellow with character display and sound), “Warning” (blinks in red with character display and sound), and “Danger” (blinks in red with character display and sound).
- By tapping the display area of “Color,” the display color of geofence can be specified via color palette.

6. Tap “✓.”

---

## ■ Setting circle type

1. Open the “Geofence Basic Settings” screen in the same manner as “■ Setting wall type.”
2. Tap “Circle.”
3. Set “Radius,” “Height,” “Dimension,” etc.



4. Tap “✓.”

## ■ Setting line type

1. Open the “Geofence Basic Settings” screen in the same manner as “■ Setting wall type.”
2. Tap “Line.”
3. Set “Radius,” “Alert Type,” etc.



4. Tap “✓.”

---



### 5.5.3 Setting alert type

---

Set the sound type, sound volume, and repetition for the five alert types.

1. Tap “Alert Settings” on the “Geofence Settings” screen to open the “Alert Settings” screen.



2. Change the settings according to the following:
  - You can select a sound type from 12 options: F-1 to H-4.
  - You can hear the set sound by tapping .
  - When you tap  to turn it on (displayed in yellow), the sound will be repeated.
  - Tap  to adjust the sound volume in five steps.
3. Tap “✓.”

---

### 5.5.4 Setting detection area

---

Set the following items related to collision detection in order to detect approach or contact to the geofence.

- Collision detection area of work equipment
- Collision detection angle and body area

#### Supplementary explanation

- Setting a relatively large value in accordance with the use conditions of the geofence function enables detection with some allowance.



1. Tap “Collision Detection Settings” on the “Geofence Settings” screen to open the “Collision Detection Settings” screen.

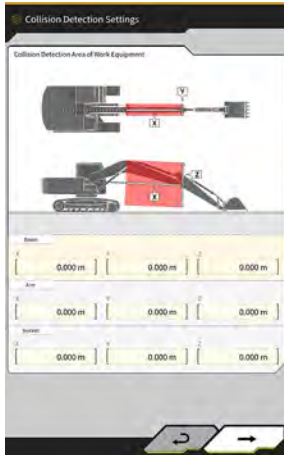

2. In “Collision Detection Area of Work Equipment,” set the target area for displaying an alert when the work equipment contacts with the geofence.

### Supplementary explanation

Measure the X, Y, and Z values of “Boom,” “Arm,” and “Bucket” and then enter the values following the screen instructions.

3. Tap “→” to display “Collision Detection Angle and Body Area.”

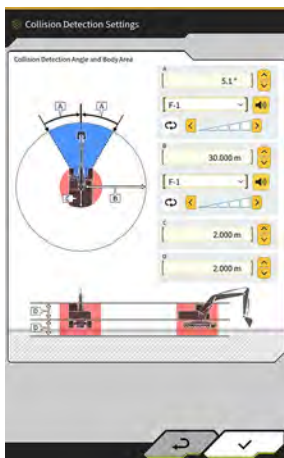

4. Set the area for detecting approach to the geofence, the area having a risk of contact during swinging, etc.

### Supplementary explanation

- Set the following values for the items A to D.
  - A: Set the angle for determining a contact with the geofence during swinging. If the geofence exists within the determination angle, the geofence radar will turn yellow on the guidance screen.
  - B: Set the radius for detecting the geofence. If the geofence exists within the detection radius, the geofence radar will be displayed on the guidance screen.
  - C: Set the radius for determining a contact of the body.
  - D: Set the height for determining a contact of the body.

5. Tap “✓.”

## 5.5.5 Creating geofence

1. Tap  to open a menu.



2. Tap "Project File" to open the "Project File" screen.



3. Tap  of the target project for creating geofence to open the "Project Settings" screen.



- 
4. Tap  to open the “Geofence List” screen.

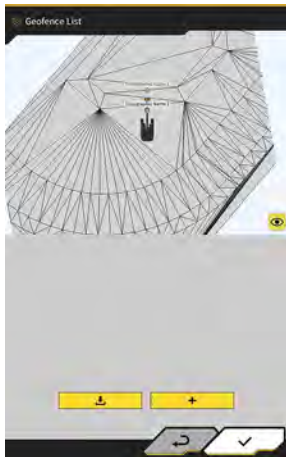

5. Tap  to open the “Create New Geofence” screen.

### ■ Creating wall type

1. Select “Wall” on the “Create New Geofence” screen.





2. Tap “✓” to open the “Geofence Details” screen.



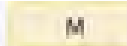
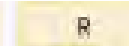

3. Set the items such as “Name.”

### Supplementary explanation

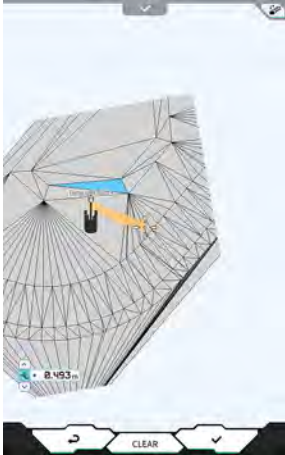
- Select a cutting edge position    at A and B, and then tap  to enter the cutting edge coordinates.
- By tapping  at A or B after entering the cutting edge coordinates at A and B, you can adjust the geofence position by dragging on the design surface.

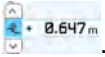

- The plan/3D display can be switched by tapping  at the top right corner of the design surface.
- Adjust the height offset with .
- After setting each item, tap  at the top right of the "Geofence Details" screen to check the geofence on the design surface.

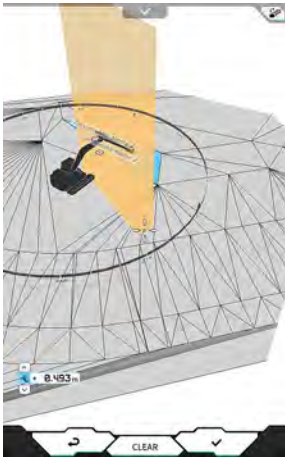

4. Tap "✓."

## ■ Creating circle type

1. Select "Circle" on the "Create New Geofence" screen.
2. Tap "✓" to open the "Geofence Details" screen.



3. Set the items such as "Name."

### Supplementary explanation

- For the usage of each button, refer to "■ Creating wall type."
- When "2D" is not selected, a value can be set for the height H.
- When "2D" is selected, the patterns of "contact with construction machine (in area)" and "exit of construction machine from geofence (out of area)" can be selected for "Alert Type."

4. Tap "✓."

## ■ Creating line type

1. Select "Line" on the "Create New Geofence" screen.
2. Tap "✓" to open the "Geofence Details" screen.

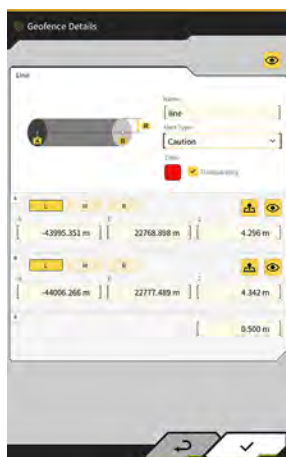

3. Set the items such as "Name."

### Supplementary explanation

- For the usage of each button, refer to "■ Creating wall type."

4. Tap "✓."

---

## 5.5.6 Display on guidance screen

---

If the geofence exists within the detection area, the geofence radar will be displayed in blue at the top right of the guidance screen. If the geofence exists within the range of collision detection angle, the geofence radar will turn yellow.



If the construction machine contacts with the geofence, the corresponding geofence will be highlighted, causing a pattern to be displayed on the screen or sound notification to be issued according to the alert type.

### Supplementary explanation

- When you set “Detection Area Display Mode” to “ON” on the “Application Settings” screen, the geofence detection area can be checked on the guidance screen.

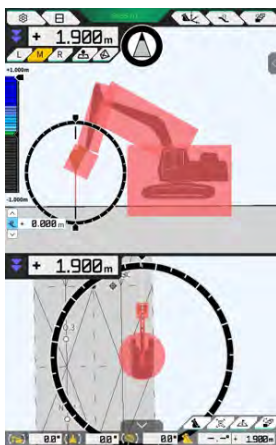

## 5.5.7 Downloading geofence

1. Tap  to open a menu.

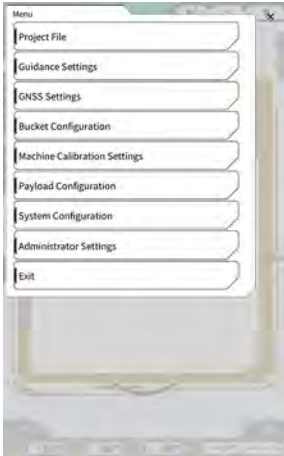

2. Tap "Project File" to open the "Project File" screen.



3. Tap  of the target project for downloading geofence and open the "Project Settings" screen.



- 
4. Tap  to open the "Geofence List" screen.

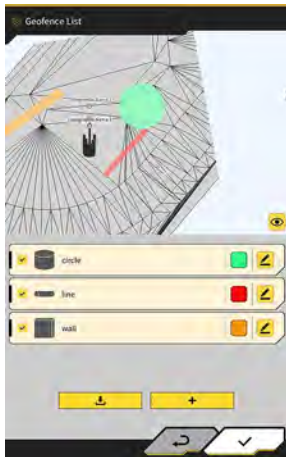

5. Tap  to open a confirmation window.

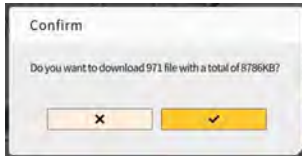

6. Tap "✓" to download the geofence from the server.

### Supplementary explanation

- The progress status is displayed during download.

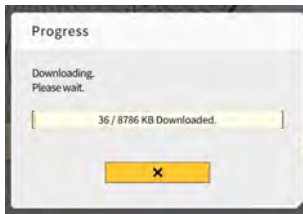



## 5.5.8 Editing geofence

1. Tap  to open a menu.



2. Tap "Project File" to open the "Project File" screen.



3. Tap  of the target project for editing geofence and open the "Project Settings" screen.



- 
4. Tap  to open the “Geofence List” screen.

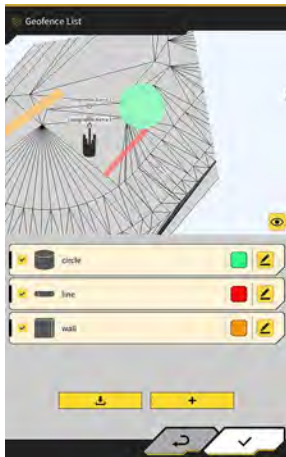

### Supplementary explanation



- You can disable the setting by unchecking a created geofence displayed on the “Geofence List” screen.

5. Tap  of the edit target geofence to open the “Geofence Details” screen.



6. Set each item and tap “✓.”

### Supplementary explanation

- Tapping  at the bottom left of the screen copies the geofence.
- Tapping  at the bottom left of the screen deletes the geofence.

## 5.6 Using simulator function

Using the simulator function, you can use the application without connecting to a device such as GNSS controller or the Internet. The simulator function allows the use of 2D/3D Machine Guidance for training or demonstration as in the case of connecting to the GNSS controller.

### 5.6.1 Switching to simulator mode

1. Set “Simulator Mode” to “ON” on the “Common Settings” screen.



2. Tap “✓.”

### 5.6.2 Operating simulator screen

1. On the start-up screen, tap “Machine Guidance” to display the main screen of Machine Guidance. If no project file is set, “Project file is not selected” will appear.



#### Supplementary explanation

- If a project file has been set, the design data will be displayed.

2. Tap  to open a menu.



3. Tap "Project File" to open the "Project File" screen.



4. Tap  to select a project file in the tablet terminal.



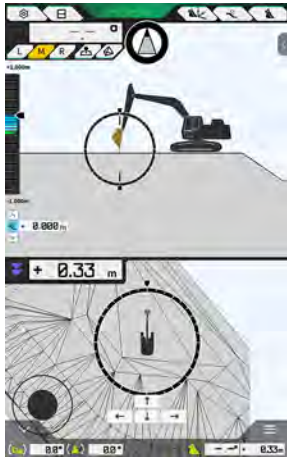

#### **Supplementary explanation**

- The extension of a project file is ".rpz".
- The project files used in the simulator mode are managed separately from those normally used.
- The project files used in the simulator mode are created in the same manner as those normally used.

5. Operate the main screen of the simulator mode.



### Supplementary explanation

- The display of the GNSS status button is fixed to “3DMG Simulator.”
- Tapping  or  moves the construction machine in the arrow direction.
- Tapping  or  turns the construction machine in the arrow direction.
- You can move the construction machine freely using the black circle (●) at the bottom left of the screen in a similar manner to a joystick.

## 5.6.3 Restrictions in using simulator function

### Notice

- The following shows main restrictions in using the simulator function.
  - Some functions and menu items, such as payload meter and geofence, cannot be used or not displayed.
  - The three-split screen display cannot be selected.
  - Neither project files nor buckets can be downloaded from the server.

### ■ Menu

When using the simulator function, the following items are unavailable in the menu.

- Extension arm calibration settings
- Payload configuration
- Geofence settings
- Administrator settings

---

## ■ Machine guidance screen

There are following restrictions related to the Machine Guidance screen in using the simulator function.

- The displayed position of the construction machine is different from the actual position.
- Since the GNSS controller is not connected, the errors that are premised on the connection with a controller such as GNSS are not displayed.
- The three-split screen display cannot be selected.
- When you disable the simulator function, the heat map will be initialized.

## ■ Project files

There are following restrictions related to project files in using the simulator function.

- Project files cannot be downloaded from the server.
- Geofence cannot be created.
- Design surface cannot be created from line work.
- Latest projection list cannot be downloaded.
-  button cannot be used on the "Add Control Point" screen.
- The projects created in the simulator mode can only be used in the simulator mode. They cannot be used in the normal mode.

## ■ Machine guidance settings

There are following restrictions related to the Machine Guidance settings in using the simulator function.

- The setting contents of the Machine Guidance in the simulator mode are asynchronous with those in the normal mode.
- The items related to the following functions cannot be set on the "Application Settings" screen.
  - Extension arm function
  - Two-piece boom function
  - Swing boom function
  - Geofence detection area display mode

## ■ GNSS settings

There are following restrictions related to the GNSS settings in using the simulator function.

- The GNSS information cannot be used.
- The content of each item on the "GNSS Basic Settings" screen is fixed and cannot be changed.
- Neither "Soft Reset" nor "Hard Reset" is available on the "GNSS Basic Settings" screen.
- Each item on the "Ntrip Settings" screen is fixed in the unentered state and cannot be changed.

---

## ■ Bucket settings

There are following restrictions related to the bucket settings in using the simulator function.

- The following three types of buckets have been registered by default. Of the three types, the standard bucket has been installed.
  - Standard bucket
  - Slope bucket
  - Tilt bucket
- The buckets in the simulator mode can only be used in the simulator mode. They are asynchronous with the buckets in the normal mode.
- Bucket files cannot be downloaded from the server.
- You cannot tap “→” on the “Bucket Calibration” screen.

## ■ Machine calibration settings

There are following restrictions related to the machine calibration settings in using the simulator function.

- Only the position posture information is available.
- You cannot tap “→” on the “Machine Calibration” screen.
- You cannot perform calibration of the two-piece boom and swing boom models.

## ■ System management

There are following restrictions related to the system management in using the simulator function.

- “Controller Info,” “License Info,” and “Network Settings” are unavailable.

## 5.7 Using 2D Machine Guidance

Use the 2D Machine Guidance function in an environment where the GNSS information is unavailable or the GNSS accuracy is unstable.

### Notice

- Since the GNSS cannot be used with the 2D Machine Guidance, there are following restrictions.
  - You need to create a design surface again after moving or swinging the construction machine.
  - Project files cannot be selected.
  - Settings and information about GNSS cannot be checked.
  - Neither cutting edge position measurement nor bucket position check is available.
  - Construction history data cannot be acquired.

### 5.7.1 Enabling 2D Machine Guidance

1. Set “2DMG Mode” to “ON” on the “Common Settings” screen.



2. Tap “✓.”

### 5.7.2 Setting design surface

A design surface used for the 2D Machine Guidance can be created in the following two ways.

- When a slope angle has been determined, set the starting point and slope to create a design surface.
- When a slope angle has not been determined, set the starting and ending points to create a design surface.



1. Tap  at the top right of the Machine Guidance screen to open the subwindow.

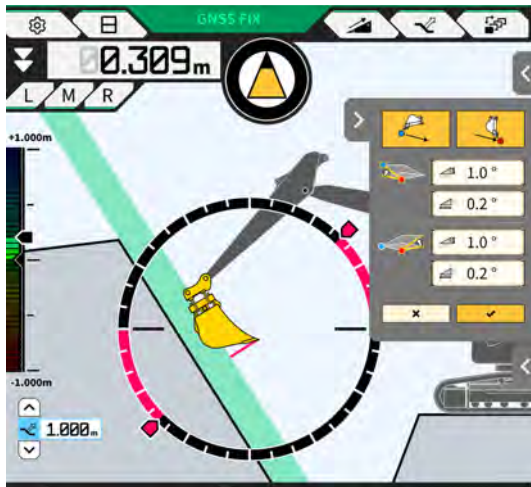

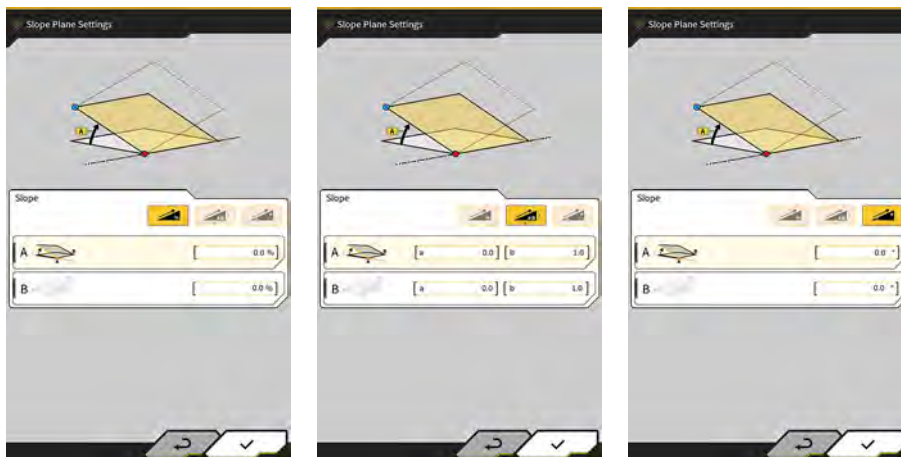

2. When a slope angle has been determined, tap  to set the coordinates of the bucket cutting edge as a starting point and then tap "✓" to set the slope angle on the "Slope Plane Settings" screen.



### Supplementary explanation

- On the "Slope Plane Settings" screen, the angle from a horizontal surface can be set in the following three types.
  - Percentage (%)
  - Ratio (a : b)
  - Degree (°)

3. When a slope angle has not been determined, tap  to set the coordinates of the bucket cutting edge as a starting point and then tap  to set the coordinates of the bucket cutting edge as an ending point.

### Supplementary explanation

- When a starting and ending points are specified, the slope angle will be calculated automatically.

4. Tap "✓."
 

A design surface will be created under the specified conditions.

## 5.8 Using 3DMG Basic

The 3DMG Basic allows you to create a 3D target surface from the bucket cutting edge position and use the Machine Guidance easily without the need of localization at worksite and preparation of design data. If 3DMG Basic is not displayed on the title screen, turn on the "3DMG Basic" item in the Common Settings.

### Notice

- The settings required to use the Machine Guidance, such as machine calibration, bucket settings, and GNSS settings, need to be configured in advance by tapping "Machine Guidance" on the start-up screen.
- The 3DMG Basic does not provide a menu for changing the settings. For error handling, you need to tap "Machine Guidance" on the start-up screen and handle errors with corresponding functions.
- When using the 3DMG Basic, the payload function is unavailable.
- The construction history data using the 3DMG Basic is not uploaded to the server. Therefore, it is not registered in the Smart Construction Dashboard.

### 5.8.1 Screen description

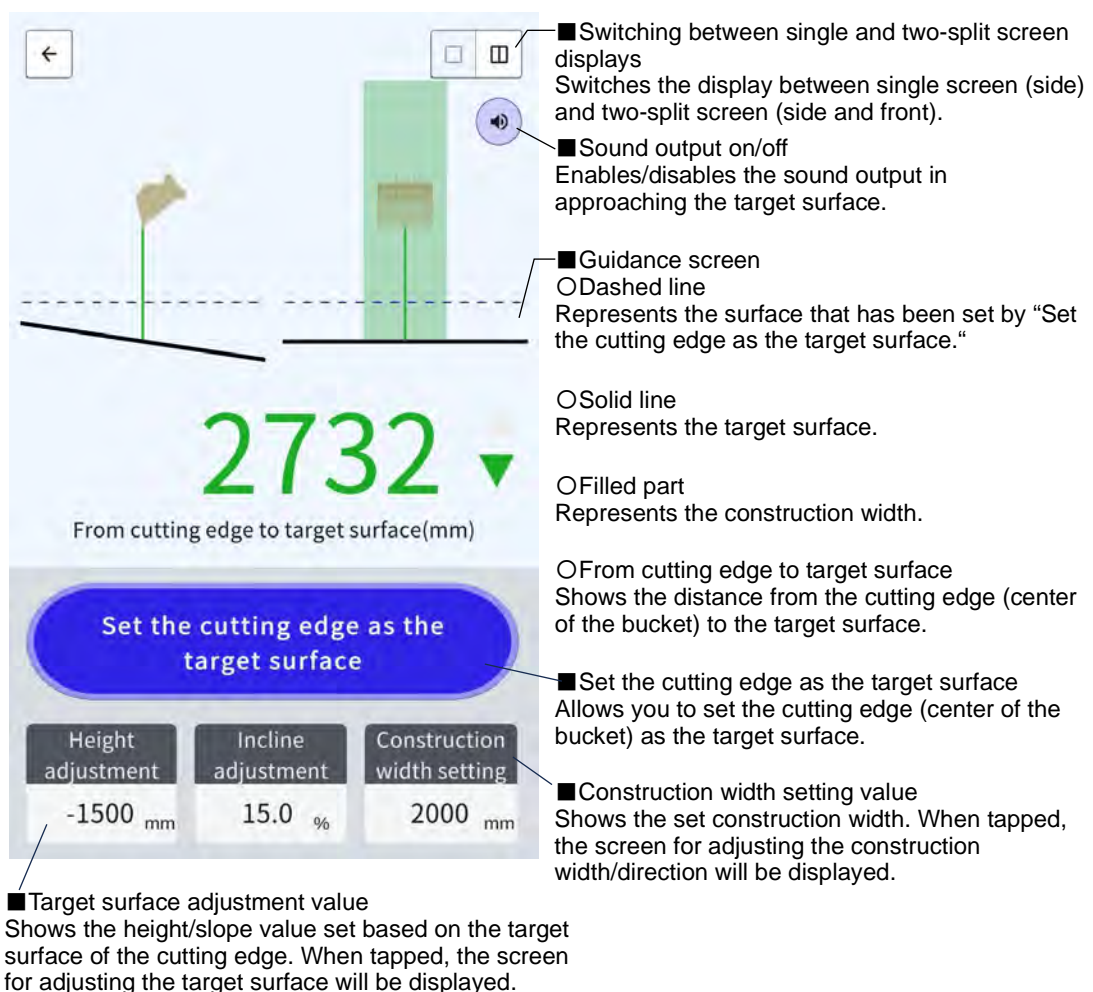

---

## 5.8.2 Setting target surface

---

1. On the start-up screen, tap “3DMG Basic” to open the guidance screen.

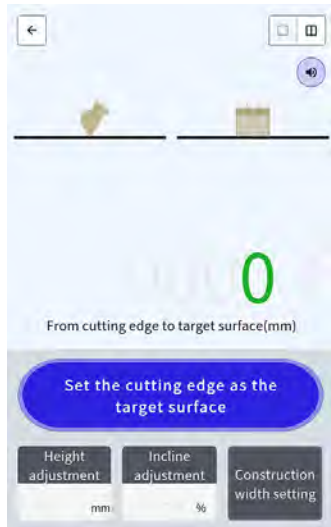

### Notice

- When starting the 3DMG Basic, the error “Controller Not Connected” due to delay in connecting with the GNSS controller or the error “Positioning Accuracy Degradation” due to GNSS taking time to fix may be displayed. In this case, wait until the connection delay is resolved and the GNSS is fixed.
- If a sensor error of IMU, etc. is displayed, check it with the Machine Guidance screen.

2. Move the cutting edge of the construction machine to the reference location.
3. Tap “Set the cutting edge as the target surface” to set the cutting edge (center of the bucket) position as the 3D target surface.

## 5.8.3 Adjusting target surface

1. Tapping “Height adjustment” or “Incline adjustment” displays numeric keys.  
 “Incline adjustment”: Offsets the set target surface in the height direction.

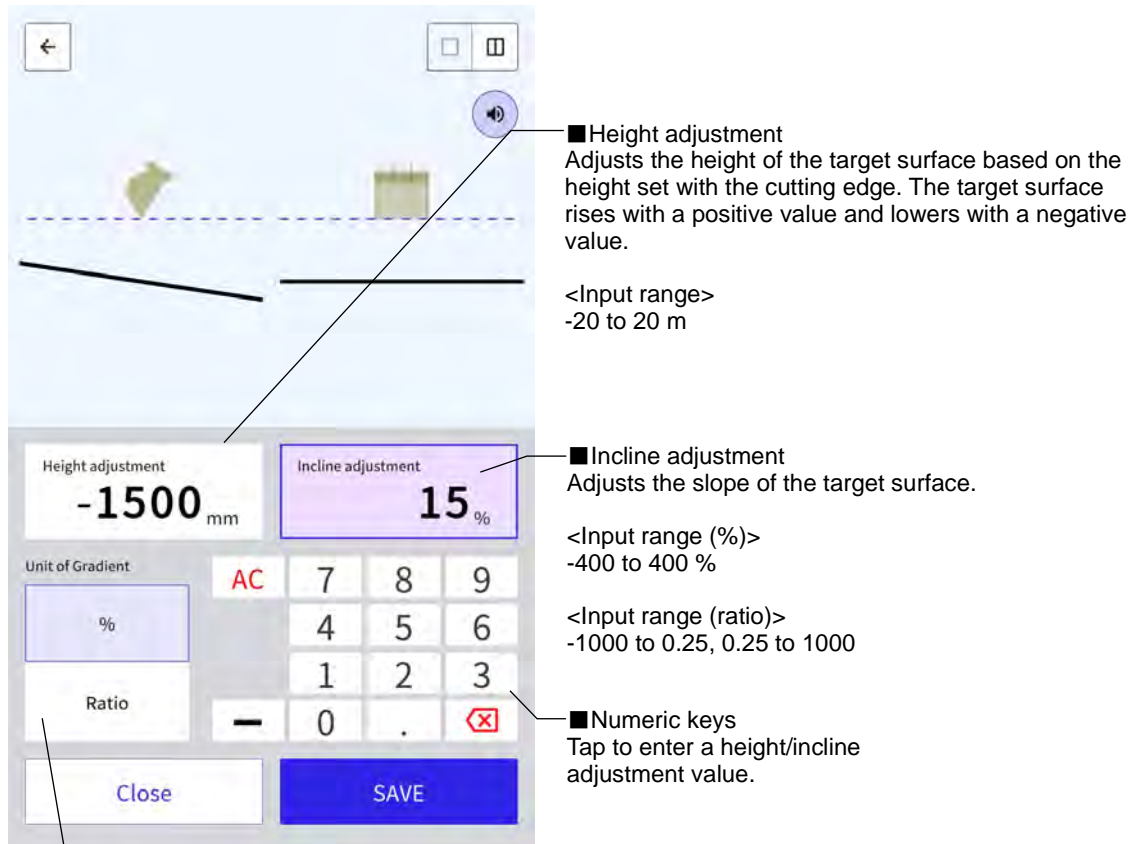

- Height adjustment  
Adjusts the height of the target surface based on the height set with the cutting edge. The target surface rises with a positive value and lowers with a negative value.  
 <Input range>  
-20 to 20 m
- Incline adjustment  
Adjusts the slope of the target surface.  
 <Input range (%)>  
-400 to 400 %  
 <Input range (ratio)>  
-1000 to 0.25, 0.25 to 1000
- Unit of length (height adjustment)  
Unit of slope (incline adjustment)  
 <Height adjustment> Switches the unit of length. The setting will be reflected to the guidance screen.  
 <Incline adjustment> Switches the unit of slope. The setting will be reflected to the guidance screen.
- Numeric keys  
Tap to enter a height/incline adjustment value.

2. Enter a value of the target surface and then tap “SAVE.”

### Supplementary explanation

- With “Height adjustment,” the target surface height set with the cutting edge is used as a reference.
- With “Incline adjustment,” the direction of the bucket in setting the target surface with the cutting edge is used as a reference.

## 5.8.4 Adjusting construction width and direction

With the construction width and direction set, the areas of width and direction are displayed in colors on the guidance screen.

1. Turn the work equipment in the construction direction and align the center of the bucket cutting edge with the center of the construction width.
2. Tap “Construction width setting.”
3. The construction direction is set to the direction of the work equipment by default.
4. Enter a construction width using numeric keys.
5. Tap “SAVE” to move to the guidance screen and start construction.

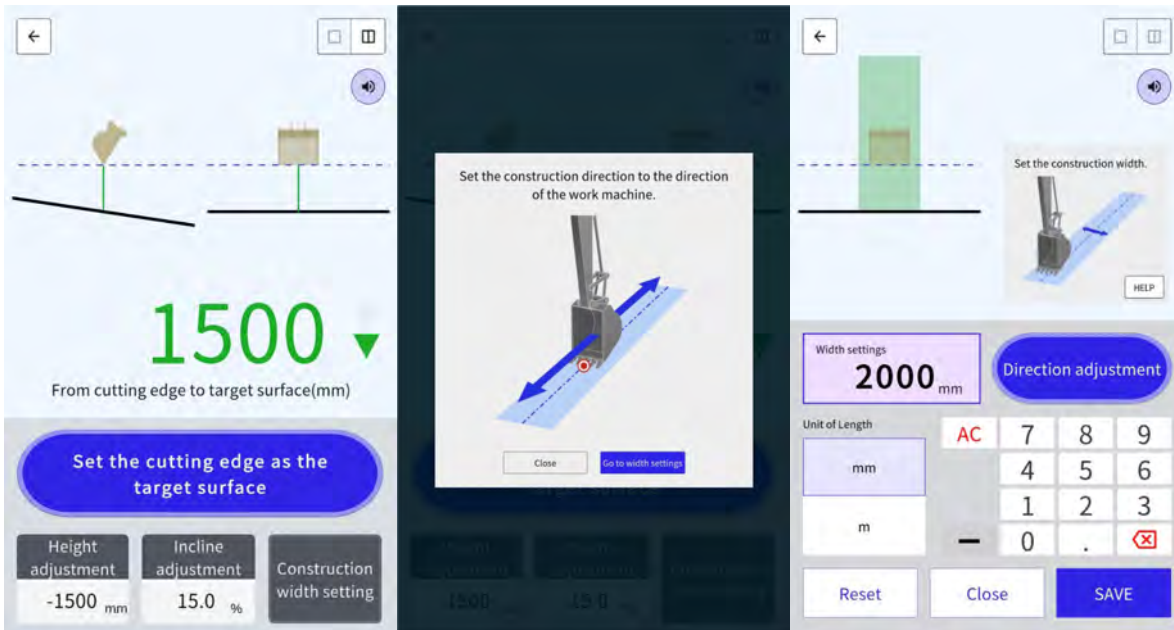

When you align the center of the bucket cutting edge with any two points and perform measurement, the construction direction connecting the two points can be set.

1. Tap “Direction adjustment.”
2. Align the center of the bucket cutting edge with a point to be set as the construction direction and then tap “Set the bucket cutting edge as point A.”
3. Align the center of the bucket cutting edge with the other point and then tap “Set the bucket cutting edge as point B ” to set the construction direction.

The following two colors are used for the display on the guidance screen.

- The bucket cutting edge exists in the colored area and faces in the direction of the construction width within the range of  $\pm 0.5^\circ$ .  
Also, the bucket cutting edge position is higher than the target surface.

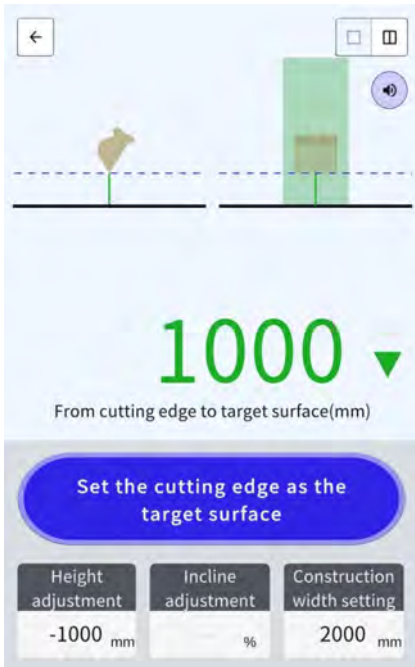

- The bucket cutting edge exists out of the colored area.
- The bucket cutting edge exists in the colored area, and there is a deviation of  $\pm 0.5^\circ$  or more from the direction of the construction width.
- The bucket cutting edge position is lower than the target surface.

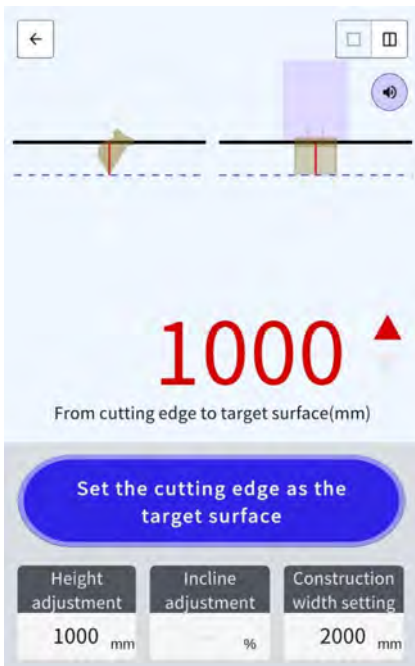

---

## 5.8.5 Working with guidance screen

---

The guidance screen shows the distance from the cutting edge (center of the bucket) to the target surface.

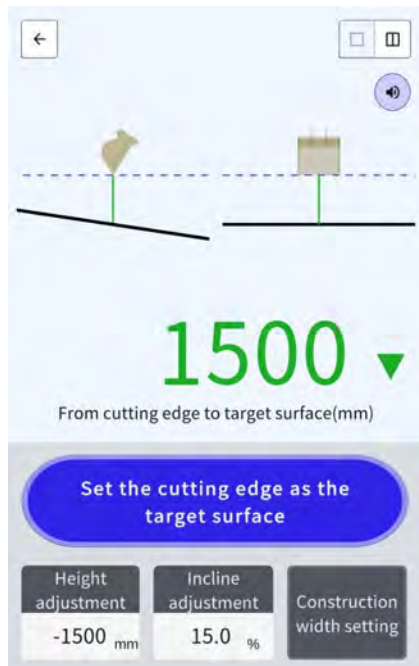

- The cutting edge position set with “Set the cutting edge as the target surface” is displayed as dashed line.
- The target surface is displayed as solid line.

## 5.9 System management

The “System Configuration” screen allows you to select the following functions in the menu.

|                        |   |
|------------------------|---|
| Controller Info        | Displays the information about the Kit, including the firmware version. |
| License info           | Displays the license information of controller.                         |
| Network Settings       | Allows you to check/change the network settings of the Kit.             |
| Sensor Data Monitoring | Displays GNSS and sensor data.  |
| System Log Upload      | Upload system log data to server for detailed investigation.            |

1. Tap  to open a menu.



2. Tap “System Configuration.”





---

## 5.9.1 Checking controller information

---

1. Tap “Controller Info“ on the “System Configuration“ screen.  
The controller information of the Kit will be displayed.

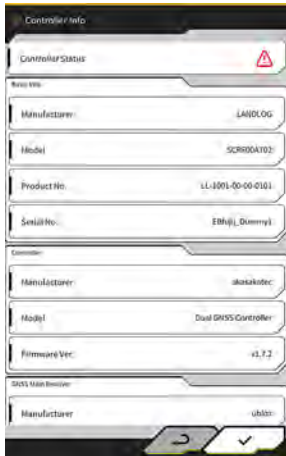

2. Tap “✓.“  
The previous screen will be displayed.

---

## 5.9.2 Checking/changing network settings

---

1. Tap “Network Settings“ on the “System Configuration“ screen.  
The network settings of the Kit will be displayed.



2. If there are any changes to make, tap the text box for manual input.
3. Tap “✓.“  
The previous screen will be displayed.

---

## 5.9.3 Checking sensor information

---

1. Tap “Sensor Data Monitoring“ on the “System Configuration“ screen.  
GNSS and sensor information of the controller will be displayed.



2. Tap "✓."  
The previous screen will be displayed.

## 5.9.4 Uploading system log data

1. Tap "System Log Upload" on the "System Configuration" screen.  
System log data in the tablet will be uploaded and confirmation window will appear.

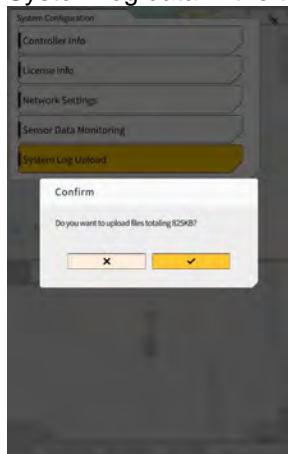

2. Tap "✓."  
Log data will be uploaded and previous screen will be displayed.

## 5.10 Administrator settings

The “Administrator Settings” screen allows you to select the following functions in the menu.

|                                 |   |
|---------------------------------|---|
| Controller Settings             | Allows you to check or change the controller settings.  |
| Network Settings                | Allows you to check or change the network settings.   |
| Server Settings                 | Allows you to check or change the server settings.  |
| System Settings                 | Allows you to check or change the system settings.  |
| Machine Calibration Settings    | Displays the list of calibration information about the Kit-equipped machine.<br>It can also be corrected. |
| Product Setting                 | Allows you to check the product settings.   |
| Administrator Guidance Settings | Allows you to check the administrator guidance settings.  |

1. Tap  to open a menu.



2. Tap “Administrator Settings.”



## Notice

- A pop-up window to enter the password will appear if “Lock with Admin Password” is set to “ON” on the “System Settings” screen. In this case, enter the password and then tap “✓.”

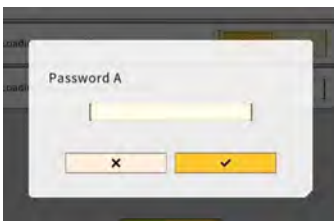

## 5.10.1 Checking controller information

1. Tap “Controller Settings” on the “Administrator Settings” screen. The controller settings of the Kit will be displayed.



2. Tap “✓.”  
The previous screen will be displayed.

---

## 5.10.2 Setting network

---

1. Tap “Network Settings” on the “Administrator Settings” screen.  
The list of current network settings will be displayed.



2. Change the settings.

### Notice

- Usually you do not need to change the network settings.

### Supplementary explanation

- If “Data Logging” is set to “OFF,” no logs will be acquired. Do not set it to “OFF” unnecessarily.

3. Tap “✓.”  
The changes will be reflected and the display will return to the previous screen.

---

## 5.10.3 Changing server settings

---

### Notice

- Do not change the server settings unless otherwise instructed.  
Otherwise, the system may not work normally.

1. Tap “Server Settings“ on the “Administrator Settings“ screen.  
The current server settings will be displayed.



2. Change the settings.
3. Tap “✓.“

## 5.10.4 Changing system settings

### Notice

- If you set “Admin Password” and set “Lock with Admin Password” to “ON”, you will not be able to display the “Administrator Settings“ screen unless you enter the password. If you want to prevent accidental system changes, set an administrator password.

1. Tap “System Settings“ on the “Administrator Settings“ screen.  
The current system settings will be displayed.



2. Change the settings.

### Supplementary explanation

- By setting “Debug Mode” to “ON,” the debug information will be displayed on the screen.
  - “Debug Mode” must not be set to “ON” unless troubleshooting is to be performed.
3. Tap “✓.“  
The changes will be reflected and the display will return to the previous screen.

## 5.10.5 Changing machine calibration settings

### Notice

- Each setting item can be changed; however, since changes cause the calibration setting value to change, usually do not make changes. If you need to make changes, refer to the Instructions for Installation. The distribution destination of the Instructions for Installation, the ID, and the password are found on the paper included with the product.

1. Tap “Machine Calibration Settings” on the “Administrator Settings” screen to open the “Machine Calibration Settings” screen.



2. Tap “Machine Calibration Settings” to open the “Machine Calibration Settings” screen. The list of current calibration settings will be displayed.



3. Change the settings and tap “✓.”  
The changes will be reflected and the display will return to the previous screen.

## ■ Restoring machine calibration settings

When the replacement of the GNSS controller is performed, the machine calibration files, which have been saved in the server in advance, are downloaded to restore the settings.

### Notice

- To restore the machine calibration settings, update the tablet application to v1.0.04 or later.

1. Tap “Machine Calibration Settings” on the “Administrator Settings” screen to open the “Machine Calibration Settings” screen.
2. Tap “Restore Machine Calibration” to open the “Restore Machine Calibration” screen.



### Supplementary explanation

- On the “Restore Machine Calibration” screen, the list of acquired machine calibration files is displayed.



3. If the restoration target calibration file is not displayed, tap  to open the “Machine Calibration File Download” screen.



### Supplementary explanation

- On the “Machine Calibration File Download” screen, the list of the machine calibration files saved in the server is displayed.
- You can also read the machine calibration files saved in the local storage of the tablet terminal by tapping . In that case, the read date will be displayed at the file name.



4. Tap  of the acquisition target machine calibration file to download and then return to the “Restore Machine Calibration” screen.
5. Tap  of the restoration target file to open the “Apply Machine Calibration” screen.



6. Confirm the restoration contents and tap “✓.”

### Supplementary explanation

- When you tap “✓,” the notice window asking whether to update the setting contents of the controller will be displayed.



- Tap  to delete the machine calibration file read into the tablet.
7. Check that the bucket cutting edge position is correct.

---

## 5.10.6 Checking product settings

---

1. Tap “Product Setting” on the “Administrator Settings” screen.  
The current product setting will be displayed.

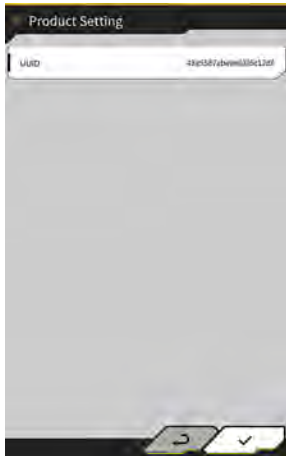

### Supplementary explanation

- UUID indicates an ID unique to the Kit. It cannot be changed.
2. Tap “✓.”  
The previous screen will be displayed.

---

## 5.10.7 Setting administrator guidance

---

### Notice

- Do not change the guidance settings unless otherwise instructed.  
Otherwise, the system may not work normally.

1. Tap “Administrator Guidance Settings” on the “Administrator Settings” screen.  
The user settings of the guidance will be displayed.



2. Change the settings.
3. Tap “✓.”  
The changes will be reflected and the display will return to the previous screen.

# 6. Payload meter (optional)

## 6.1 Setting payload meter

### 6.1.1 Basic settings

To use the payload meter, you need to purchase a separate license for Smart Construction Fleet (lite).

If you are already using Smart Construction Fleet, follow the Smart Construction Fleet Quick Guide (otherwise, follow the Smart Construction Fleet Lite Quick Guide) to perform the initial settings and then make the settings on your tablet.

#### Supplementary explanation

- To use this system, you need your Smart Construction Portal or LANDLOG account.
- If you have neither of them, register from the website below.  
Smart Construction Portal URL: <https://scportal.pf.sc-cloud.komatsu>  
LANDLOG Portal URL: <https://www.landlog.info/>
- When you set "Standalone Mode" to "ON" on the "Machine Settings" screen, weight measurement with the payload meter without connecting to Smart Construction Fleet can be performed for demonstration or operation check.

#### ■ Setting tablet terminal

1. Start Smart Construction Pilot on the tablet terminal.



2. Tap "Payload Meter."



3. Tap .



4. Tap "Basic Settings."



5. Tap .  
The password entry window will be displayed.

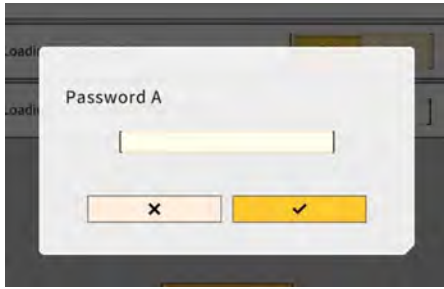

6. Enter "31415" to the "Password A" field and then tap "✓."

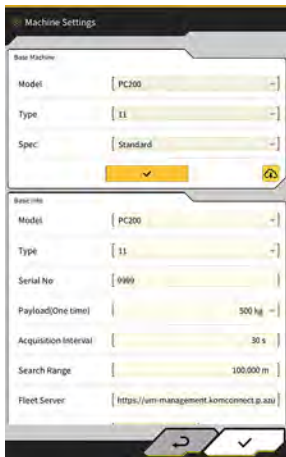

7. Select "Model," "Type," and "Spec" (standard or long arm) in the "Base Machine" section on the "Machine Settings" screen.

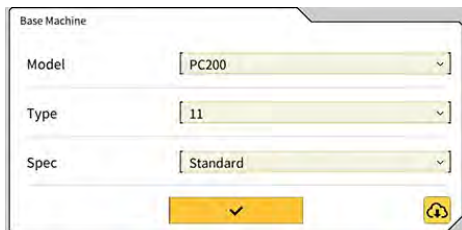

### Supplementary explanation

- The selectable items in the "Base Machine" section vary by the setting content of "Region" on the "Common Settings" screen.
- Tap "Reload" to acquire the latest payload parameter setting file from the server.

8. Tap “✓” in the “Base Machine” section and then tap “✓” in the confirmation window.  
The standard parameters of the selected model, type, and specification will be selected on the tablet terminal and the settings are saved in the controller.

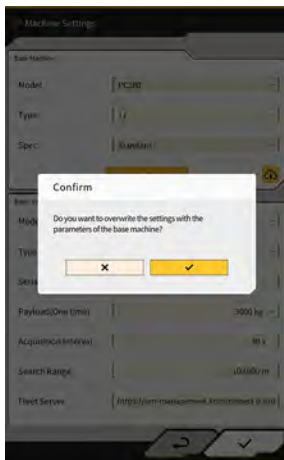

9. Enter the serial number of the Kit-equipped machine in the “Basic Info” section.



### Supplementary explanation

- Based on the information of model, type, and serial number, the linkage with Smart Construction Fleet (lite) is established. Be sure to enter the model, type, and serial number correctly.
10. Change the following settings as needed:
    - “Payload(One time)” [kg/ton]: Maximum weight value on the meter display
    - “Acquisition Interval” [s]: Smart Construction Fleet (lite) information update interval
    - “Search Range” [m]: Search range for nearby trucks

### Supplementary explanation

- The unit of “Payload(One time)” can be changed with “Weight Unit” on the “Common Settings” screen.
11. By tapping “✓” on the “Machine Settings” screen, the settings will be saved and the display will return to “Basic Settings.”

- By tapping “✓” on the “Basic Settings” screen, the settings will be saved and the display will return to the load meter screen.  
When linked with Smart Construction Fleet (lite), the truck list set by Smart Construction Fleet (lite) will be displayed on the load meter screen.



### Supplementary explanation

- If the truck list is not displayed, there may be an error in the model, type, and serial number information registered on the tablet terminal or Smart Construction Fleet (lite).
- When you set “Standalone Mode” to “ON” on the “Machine Settings” screen, only “Default Dump” is displayed in the truck list.

## 6.1.2 Changing bucket

When changing the bucket, a bucket file in which the weight has been set needs to be selected. Also, the payload meter needs to be calibrated after selecting a bucket file.

- Tap “Bucket Configuration” in the Machine Guidance menu to open the bucket file settings screen and then select a bucket file. If no bucket file exists, create it.  
For details, refer to “5.2 Changing bucket configuration.”

### Notice

- The payload parameters are calculated automatically based on the dimension and weight information of the bucket file. Select a correct bucket file.

### Supplementary explanation

- You can also open the “Bucket Configuration” screen by tapping “Bucket Configuration” in the payload meter menu.
- After selecting a bucket file, perform a calibration (refer to the section 6.2).

## 6.2 Calibrating payload meter

### ⚠ WARNING

#### THERE IS A POSSIBILITY OF SERIOUS INJURY OR DEATH.

- Before performing the calibration, make sure that your surroundings are safe. Check whether people/obstacles are present around, and sound the horn before starting the work.
- Perform the swing work before calibration. During swinging, be sure to visually check the swing direction. Make sure that other workers are kept out of the turning radius throughout the work.

### Notice

- If soil is attached to the bucket, remove it. With soil attached to the bucket, proper calibration may not be performed.

Be sure to perform the calibration before using the payload meter for the first time or after changing the model or bucket. We recommend that the calibration be performed once a month.

### 6.2.1 Unloaded calibration

Perform the unloaded calibration according to the following procedure. When performing the calibration, perform the operation that is similar to the usual swing with boom up.

### Notice

- Proper calibration may not be performed if the construction machine/work equipment vibrates during the calibration work. Perform the boom up operation as smooth as possible.

1. Move the Kit-equipped machine to a flat and hard ground, such as on a concrete surface.
2. Warm up for about one minute to bring the oil temperature to 30 °C or higher.
3. Tap  on the payload meter screen and then tap "Unloaded Calibration." When the calibration screen is displayed, perform the steps 1 and 2.

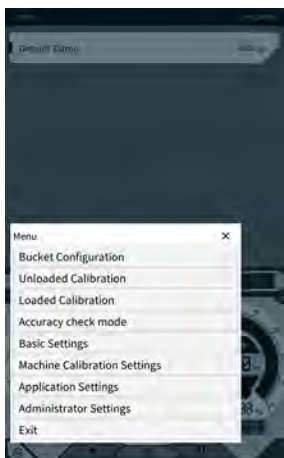



4. [Step 1] As shown in the figure, adjust the work equipment angle so that the boom angle (A) is within the range of 60 to 70 degrees and the arm angle (B) is 100 degrees. Ensure that the bucket is level with the ground at the front. The current angles are displayed on the right side of "Step 1."

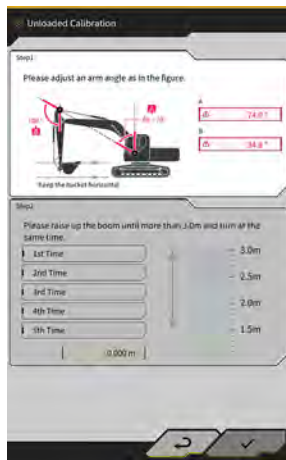

5. When the adjustment of work equipment angle is completed in the step 1, the process automatically moves to the step 2.  
 [Step 2] Slowly perform hoisting and swinging (simultaneous operation of boom up and swinging; swinging of about 90 degrees is recommended) with a throttle at a medium speed (half) until the arm top exceeds the specified height.

## Notice

- Do not operate the arm and the bucket during hoisting and swinging.

The height of the arm top is displayed by value at the bottom of "Step 2" and by indicator on the right side.

When the height of the arm top exceeds the set value, the arrow of the height indicator changes to "↓."

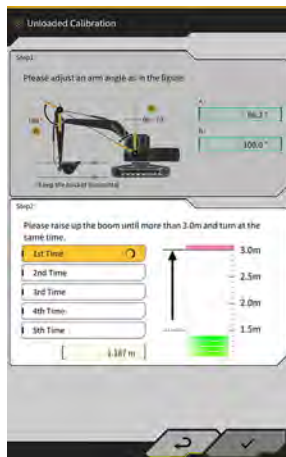

6. [Step 2] Lower the boom until the arm top becomes lower than the specified height and then return to the posture of the step 1.  
When the height of the arm top becomes smaller than the set value, the first calibration is completed (✓) and the second calibration is started.

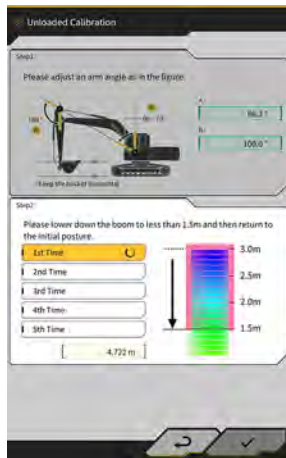

7. [Step 2] Perform the hoisting and swinging, and boom down operations four more times. The calibration operation is performed five times in total.
8. Lower the boom and confirm that the calibration is completed (✓) up to "5th Time" and then tap "✓." When the calibration is completed successfully, "Success" will appear. Unloaded calibration result will be saved in bucket file.

## 6.2.2 Loaded calibration

If the accuracy of the payload meter cannot be secured with the unloaded calibration, perform a loaded calibration.

### Notice

- When the accuracy of the payload meter is secured with the unloaded calibration, there is no need to perform a loaded calibration.

### ■ Preparation

1. Move the construction machine to a flat and hard ground, such as on a concrete surface.
2. Warm up to bring the oil temperature to 30 °C or higher.
3. Prepare a weight of known weight.

### Notice

- We recommend the use of a weight satisfying the following conditions. If the weight and volume are too small, the calibration accuracy may be degraded.
  - The weight that is more than half of the rated weight of the bucket
  - The volume that makes the bucket full
- A truck scale cannot be used because the loaded calibration is performed by entering a correct weight.

4. Select a bucket file in which the weight has been set.
5. Perform the unloaded calibration.

## Notice

- If the unloaded calibration has not been performed, an error will be displayed when the "Loaded Calibration" screen is opened.

### ■ Performing calibration

1. Set a weight of known weight in the bucket.
2. On the start-up screen, tap "Payload Meter" to open the payload screen.
3. Tap  to open a menu.

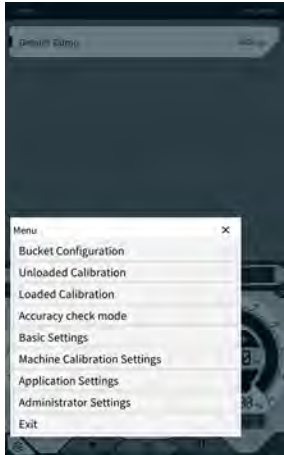

4. Tap "Loaded Calibration" to open the "Loaded Calibration" screen.

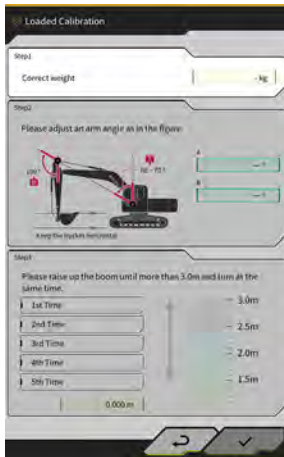

### Supplementary explanation

- The screen is displayed in either the standard or two-piece boom specification, depending on the base machine settings with the payload meter.
- You can also open the "Loaded Calibration" screen by tapping  on the Machine Guidance screen and then tapping "Payload Configuration" and "Loaded Calibration" in this order.

5. Enter the correct weight of the weight to "Correct weight."
6. Adjust the posture of the construction machine to the angles displayed on the screen.
7. Repeat the boom up and swinging operations five times following the screen instructions.

### Supplementary explanation

- Tap a finished measurement to perform the calibration again from the tapped measurement.

- 
- 
8. Tap “✓” to save the calibration result.  
When the calibration is completed successfully, "Success" will appear.

### Notice

- The value of “Correction formula A” on the payload machine settings screen is changed based on the calibration result. The default value of “Correction formula A” is “-0.08.”
- The result may vary depending on the operation method used in the calibration. Perform the loaded calibration five times and use the average of the values displayed at “Correction formula A.”

### ■ Checking accuracy

After the loaded calibration is completed, check the accuracy of the payload meter using actual load or the like.

- Example 1: Checking accuracy using soil (measure the actual weight of soil using a spring scale or the like and then perform payload measurement)
- Example 2: Loading truck (measure with a truck scale and compare with the payload measurement value)  
Check the payload meter accuracy five times each for the three posture: arm at a long distance, arm at the center, and arm at a short distance, which means 15 times in total. It is no problem as long as fluctuations in the accuracy are within  $\pm 5\%$ .

### Supplementary explanation

When using a weight, the following series of operations is counted as one time since the payload value cannot be determined by turning the bucket: dig by construction machine → swing → stop swinging → read the gauge at the bottom right of the payload meter screen → restart the application.

## 6.3 How to use payload meter

### WARNING

#### THERE IS A POSSIBILITY OF SERIOUS INJURY OR DEATH.

- The payload meter is intended to assist the worker in measuring the load capacity and reduce the burden of load capacity management. It is not for preventing overloading.
- Do not operate the machine while operating the tablet terminal. When operating the tablet terminal, stop the machine operations.
- When operating the tablet terminal, be careful not to accidentally operate the control lever.
- Give priority to checking the safety of your surroundings. Do not look fixedly at the tablet terminal screen.
- During swinging, be sure to visually check the swing direction.
- Since it involves the swing work, make sure that other workers are kept out of the turning radius throughout the work.

### Notice

- The payload meter has a limit to its performance. The weight indicated by the payload meter may vary due to the effects of factors such as soil adhesion, operation method, and soil property; thus, it should be used only as a guide.
- The payload meter is not a measuring instrument that has passed the certification test. It should not be used for trading or certification.
- When using it for trading or certification, check with a measuring instrument such as a truck scale.
- If loading is performed with the machine body tilted excessively or in the unstable state, the load cannot be measured correctly. Perform the loading work preferably in the state where the machine is kept level and stable.
- Note that the error may vary depending on the operation method and conditions.
- When you attempt to use the payload meter functions without setting the bucket weight and performing the unloaded calibration, the following message will appear.



### 6.3.1 Display content on payload meter screen

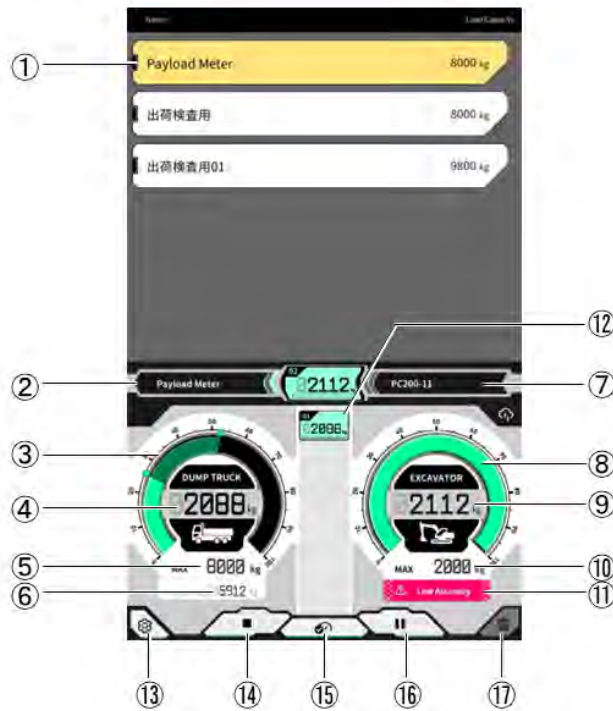

| No. | Display content   |
|-----|---|
| ①   | Truck list (truck name/maximum load capacity)           |
| ②   | Selected truck  |
| ③   | Truck load volume displayed in gauge                    |
| ④   | Truck load volume displayed in value                    |
| ⑤   | Maximum load capacity of selected truck (target weight) |
| ⑥   | Remaining weight loadable                               |
| ⑦   | Construction machine being set (model - type)           |
| ⑧   | Digging weight displayed in gauge                       |
| ⑨   | Digging weight displayed in value                       |
| ⑩   | Approximate maximum digging amount of bucket            |
| ⑪   | Caution display when loading accuracy seems to be poor  |
| ⑫   | Loading history for each time                           |
| ⑬   | Settings button   |
| ⑭   | Loading start/finish button                             |
| ⑮   | Loading result fix button                               |
| ⑯   | Pause button  |
| ⑰   | Loading result delete button                            |

---

## 6.3.2 How to operate payload meter screen

---

### ■ Selecting truck

From the truck list at the upper part of the screen, tap the target truck. The selected truck will be highlighted.

#### Supplementary explanation

- In the standalone mode, only “Default Dump” is displayed.

### ■ Starting payload measurement

Before starting digging, tap ▶ to start measurement.

### ■ Counting loading weight

When payload measurement is started and the construction machine is operated as follows: digging → cargo turning → bucket dumping, the payload value is counted when the bucket is unloaded and added to the truck loading volume.

Or tap  button to count loading weight.

### ■ Canceling loading weight

Tap the loading history to highlight it. By tapping  in that state, the highlighted history can be deleted.

### ■ Ending payload measurement

Once you have finished loading the truck, tap “■.” The payload measurement will be ended.

### ■ Pausing payload measurement

By tapping  during payload measurement, the payload will not be counted even if the bucket is unloaded. Use this when you perform another work during loading.

---

## 6.3.3 Payload meter functions

---

### ■ Meter display function

In the normal mode, both the digging weight and loading weight meters are displayed in green.



The digging weight meter is displayed in yellow when the target weight is almost reached after the digging is done once more.

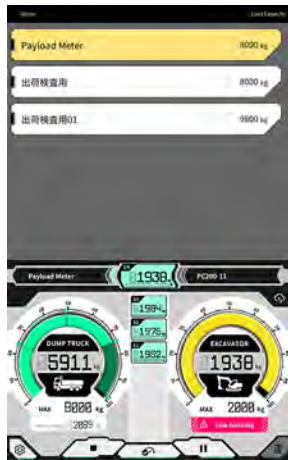

If the loading weight is estimated to exceed the target weight after the current digging weight is added, the digging weight meter will be displayed in red.

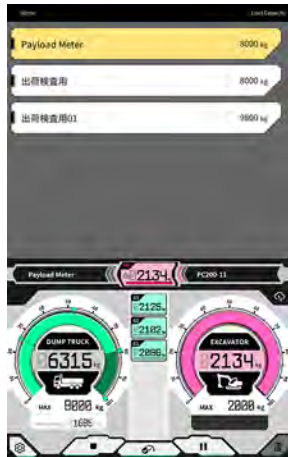

If the truck is loaded with the target weight exceeded, the loading weight meter will turn red.

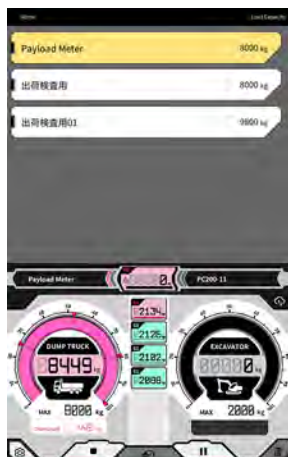



## ■ Soil volume adjustment function

### Notice

- Adjust the soil volume before swinging.

The digging weight meter displays the soil volume within the bucket in real time.  
Adjust the loading volume by reducing the soil volume within the bucket.

### Supplementary explanation

If the payload value is not reflected well in real time, it is recommended to perform the boom up operation on the spot.

## 6.3.4 Other payload functions

On the “Basic Settings” screen, you can set each payload function to “ON”/“OFF.”



### ■ Auto start

When this is set to “ON,” loading can be started automatically (▶ pressed state) when a truck is tapped and selected.

### ■ Auto stop

When this is set to “ON,” loading can be ended automatically (■ pressed state) when the ratio selected at “End loading at” of the maximum load capacity of the truck is exceeded in the payload counting.  
By tapping the list box of “End loading at,” the threshold can be selected within the range of 60 to 95 % from the pull-down list.

### ■ Loading accuracy alert

When this is set to “ON,” a caution can be issued at the bottom of the digging weight gauge when the calculation accuracy seems to be poor during loading.

The threshold for issuing a caution can be set with “Loading accuracy Alert Threshold” (minimum: 0, maximum: 1).

A value that decreases when the oil pressure is fluctuating and increases when the oil pressure is stable is used as a criterion. Since a caution is issued when the value falls to or below the threshold, the following situations occur.

- When the operation is performed keeping the oil pressure stable, a caution is not issued easily.
- When the threshold is set to a larger value, a caution is issued easily.

\* Do not change it unnecessarily.

## 6.4 Judgment by accuracy check mode

In the accuracy check mode, the payload calculation result can be judged whether it is within the standard value. The accuracy check procedures in the unloaded state can be reduced compared with before.

### Notice

- In the accuracy check mode, the digging, boom up/swinging, and bucket unloading operations are required.
- Use the accuracy check mode after configuring the following settings.
  - Machine calibration
  - Bucket file settings
  - Base machine settings with payload meter
  - Unloaded calibration with payload meter

1. On the start-up screen, tap “Payload Meter” to open the payload meter screen.
2. Tap  to open a menu.

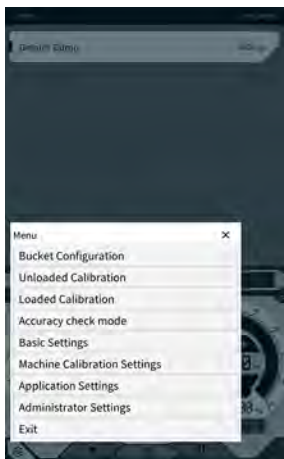

3. Tap “Accuracy check mode” to open the “Accuracy check mode” screen.



### Supplementary explanation

- You can also open the “Accuracy check mode” screen by tapping  on the Machine Guidance screen and then tapping “Payload Configuration” and “Accuracy check mode” in this order.

- Put the construction machine in the posture before digging.



- Enter a value to "Target Value" and "Tolerance."

#### **Supplementary explanation**

- Set the target weight at "Target Value." It has been set to 0 kg of the unloaded state by default.
- Set the permissible error for the target value at "Tolerance." It has been set to 100 kg by default.
- The unit of weight can be changed on the "Common Settings" screen.

- Tap "START" and operate the construction machine to perform the bucket digging, boom up/swinging, and bucket dumping operations in this order.  
Or tap  button to fix.

#### **Supplementary explanation**

- Operate the construction machine in the same way as the usual digging and loading operations.
  - To obtain good measurement accuracy, perform the boom up operation as smooth as possible. Otherwise, oil pressure pulsation results in degradation of the accuracy.
  - To end the measurement, you need to perform the bucket unloading operation.
- After performing the bucket unloading operation, the payload calculation result is judged whether it is within the tolerance range of the target value.

# 7. Product specifications

|                                    |                           |  |
|------------------------------------|---------------------------|--|
| Product Name                       |                           | Smart Construction Retrofit  |
| Controller Model Name              |                           | SCRF00AT02 / SCRF00AT03  |
| Controller Model Number            |                           | LL-1001-00-00-0101 / 2AB-06-11112  |
| Part Name                          |                           | CONTROLLER   |
| Controller Power Supply            | Rated volted              | 10 - 30V   |
|                                    | Recommended Fuse Capacity | 10A  |
| Current Consumption                |                           | 0.2A(24V)  |
| Water Resistance / Dust Resistance |                           | JIS D0203 S2 / JIS Z8901 8 types   |
| Operating Temperature Range        |                           | -30°C to +85°C   |
| Manufacturer                       |                           | EARTHBRAIN Ltd.  |
| Factory                            |                           | Akasaka Tech   |
| Controller Country of Origin       |                           | Japan  |
| Wi-Fi Specification                |                           | 802.11 a/b/g/n/ac  |
| Standards (EN,FCC)                 |                           | EN 300 328 V2.1.1 / EN 300 328 V2.2.2<br>EN 301 893 V2.1.1, EN 303 413 V1.1.1<br>EN 301-489-1 V2.2.3, EN 301-489-17 V3.1.1<br>EN 301-489-19 V2.1.1 ,EN 62368-1:2014+A11:2017<br>FCC Part 15 Subpart E:2018<br>FCC Part 15 Subpart B:2020 |
| Max EIRPs (per band and function)  |                           | WLAN2.4GHz(EN):<br>14.48 dBm eirp<br>WLAN5GHz(FCC):<br>11a: 17.86 dBm eirp, 11n-20: 17.40 dBm eirp<br>11ac-20: 17.42 dBm eirp, 11n-40: 15.47 dBm eirp<br>11ac-40: 15.34 dBm eirp, 11ac-80: 13.38 dBm eirp                                |
| Vibration                          |                           | Frequency : 8.3Hz-400Hz, Test time : 20min,<br>Acceleration:8.9G, Total vibration: max. 1mm  |
| Vibration Durability               |                           | Frequency : 66.7Hz, Test time<br>4 hours up and down, 2 hours left and right,<br>2 hours before and after, Acceleration : 8.9G   |
| Sweep Vibration Durability         |                           | Frequency :<br>8.3Hz - 400Hz, Cycle : 20 min. (1 Reciprocal),<br>Test time : 6 hours up and down,<br>6 hours left and right, 6 hours before and after,<br>Acceleration : 8.9G, Full amplitude : Max 1.0mm                                |

|   |  |
|---|--|
| Impact                                      | Impact acceleration : 50G,<br>Impact action time : 11msec,<br>Number of tests : up and down, left and right, before and after,<br>5 times in each of the 3 axes in both directions, Total 30 times |
| Salt Water Spray                            | Test temperature : 35 °C, Salt water concentration : 5%,<br>Spray volume : 0.5 -   |
| Type of Modulation                          | BPSK, QPSK   |
| Frequency Band                              | 2400-2835.5MHz, 5150-5250MHz,<br>5250-5350MHz, 5470-5725MHz,<br>5725-5895MHz,  |
| Frequency of Operation                      | 2412-2472MHz, 5180-5240MHz,<br>5260-5320MHz, 5500-5700MHz,<br>5745-5825MHz,  |
| Antenna Gain                                | 2.4GHz : 2.1dBi<br>5GHz : 2.4dBi   |
| Weight                                      | 2.1kg  |
| Emission Designation (ITU Code)             | G1D/G7D  |
| Transmit Power or Power Range               | Burst Mode Tx 11b (Duty=46.8%):488mW<br>11ac RX 5G:358mW<br>Sleep Mode:1.8mW   |
| Bandwidth                                   | 5MHz, 20MHz, 40MHz, 80MHz  |
| Channel Spacing                             | 5MHz, 20MHz, 40MHz, 80MHz  |
| GNSS Reception Specifications               | GPS GLONASS Galileo Beidou QZSS  |
| Wireless Connection Specifications (option) | RS232C   |
| Body Size ※Without Sunshade Cover           | 130mm(W) x 250mm(D) x 100mm(H)   |

# 8. Troubleshooting

## ■ Items to be checked when an error screen appears

If an error related to the IMU or pressure sensor occurs, the following error screen will appear.



If an error related to the GNSS controller or Wi-Fi connection status occurs, the following error screen will appear.

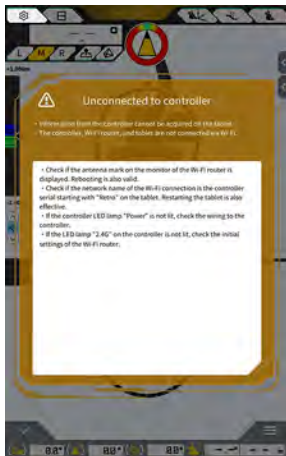

If an error related to project file settings occurs, the following error screen will appear.



If these error screens appear, check the display content and handle the situation.

If an error related to the GNSS status occurs, it will be displayed as shown below.

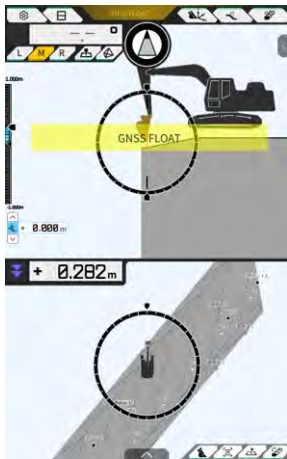

In this case, you can check the error detail by tapping the error displayed or the GNSS status button at the top of the screen.



After checking the detail, tap “✓” to return to the previous screen.

If an abnormality is found in the boom cylinder pressure during the mass adjustment (calibration) of the payload, the following caution will be displayed. In this case, check the display content and use it as a guide in executing the mass adjustment (calibration). For details about the mass adjustment (calibration), refer to the manual intended for the agents.



---

## ■ If acquisition of setting file fails

If the following files cannot be read, the corresponding backup files will be read.

- ApplicationSetting
- CompassSoundSetting
- CuttingEdgeOffset
- GuidanceSetting
- LightBarAndSoundSetting
- MainDisplayEnableUISetting
- Network
- PayloadInfoSetting
- ServerSetting
- StartupSetting
- SystemSetting
- TargetSurfaceOffset

The following files are acquired from the GNSS controller.

- BasicSetting
- CalibrationInfo
- GnssInfo
- GnssSetting
- PositionPostureInfo
- RetrofitKitInfo

If the following files cannot be read, initial value files will be created with the corresponding versions.

- ColorList
- Common\_setting
- MachineCalibrationSetting
- PayloadParameterSetting
- Product
- Version

## ■ Firmware update

If the following message appears, update the firmware to the latest version.





## ■ Other phenomena and items to be checked

| Phenomenon   | Items to be checked  |
|--|--|
| The value differs significantly when checking the accuracy of the bucket cutting edge. | <p>Are the coordinates of the bucket cutting edge changed significantly?</p> <p>⇒ Due to the fluctuation of the GNSS antenna position, the behavior of the cutting edge may change irregularly. If there is no improvement after waiting for a while, move to an open place.</p> <p>Isn't the machine shaking on an unstable ground?</p>   |
| Design data is not displayed.  | <p>Is the design data set up?</p> <p>⇒ If not set, import the design data and check if it is displayed.</p>  |
| Displays of the machine and the bucket have disappeared.                               | <p>Tap the tablet again to check if it is displayed.</p> <p>Are the bucket and calibration information set up correctly?</p>   |
| Facing angle compass does not face the front.  | <p>Is the desired design data for construction selected?</p> <p>* The selected design data is highlighted.</p>   |
| Though faced straight to the design data, the machine slants.                          | <p>Isn't the machine shaking on an unstable ground?</p> <p>⇒ If the machine is operating on an unstable ground where the machine shakes significantly, the facing angle compass may not face the front due to the response characteristics of the IMU that detects the machine posture. In this case, it is not a failure.</p> <p>Is the bucket configuration correct for the bucket equipped?</p> <p>⇒ If the bucket configuration is not correct, the facing angle compass will not be displayed correctly.</p> <p>Are there any defects in the design data, such as holes or protrusions?</p>   |
| Payload value is not displayed.  | <p>Isn't the pressure sensor setting disabled?</p> <p>⇒ Set "Boom Head/Bottom Pressure Sensor" to "ON" on the "Controller Settings" screen.</p> <p>Aren't the pressure sensors of the boom cylinder attached with the head/bottom ends reversed?</p>   |
| Payload accuracy is bad.   | <p>Isn't the work equipment shaking at the time of swinging?</p> <p>⇒ Payload calculation is available on a slope ground, but the accuracy tends to be better on a flat ground. Also, when the construction machine is shaky, the payload accuracy tends to be worse.</p> <p>Isn't the work equipment shaking at the time of calibration?</p> <p>⇒ Since the payload is calculated from the oil pressure of the boom cylinder, the payload accuracy tends to be worse when the boom is shaky.</p> <p>Isn't soil spilling at the time of swinging?</p> <p>Isn't there dirt stuck to the bucket?</p> <p>Did you perform warm-up operation?</p> <p>⇒ Warm up to bring the oil temperature to around 30 °C. Since the payload is calculated from the oil pressure of the boom cylinder, warm up with the boom cylinder at the stroke end as a precaution.</p> <p>Isn't the boom up time too short?</p> <p>⇒ The accuracy tends to be better when the boom is raised in about four seconds.</p> |

| Phenomenon  | Items to be checked  |
|---|--|
| Storage free space of tablet terminal fell to or below the threshold. | Tap “✓” in the message window displayed to delete unnecessary files such as cache files.<br>You can set the threshold with “Storage Free Space Threshold” on the “Common Settings” screen. |
| Accuracy check with payload meter resulted in NG.                     | Check that the parameters are set correctly and then perform an unloaded calibration again.  |

## ■ System status list

The table below shows the system statuses of the tablet. For the display method, refer to “4.1.2 Main screen operations.”

| Item  | Value | Error contents  |
|---|-------|---|
| AHRS<br>(Attitude and heading reference system) | 0     | No abnormality in AHRS or IMU   |
|   | 1     | BodyIMU not connected.  |
|   | 2     | MainGNSS or SubGNSS not yet measured.   |
|   | 3     | Both 1 and 2 are applicable.  |
|   | 4     | An IMU internal error occurred.   |
|   | 5     | MainGNSS is Fix or Float but the accuracy is lowered, or the heading is not fixed.  |
|   | 6     | Both 4 and 5 are applicable.  |
| Location information                            | 0     | MainGNSS is FIXED-RTK.  |
|   | 1     | MainGNSS is Float, and the accuracy equals to or lower than the high accuracy threshold.  |
|   | 2     | MainGNSS is Float, and the accuracy is between the low and high thresholds.   |
|   | 3     | MainGNSS is Float, and the accuracy equals to or higher than the low threshold; MainGNSS is DGNSS or SinglePoint; MainGNSS is unpositioned or DEAD_LOCKING; or RTCM data is unreceived. |
|   | 4     | Data not received from MainGNSS.  |
| Base station connection                         | 0     | No dropout for the last five minutes (A dropout is defined as an event that RTCM data cannot be received continuously for 30 seconds.)  |
|   | 1     | A dropout occurred in the last five minutes.  |
|   | 2     | Currently dropping out (RTCM not received for 30 seconds or more)   |
| Boom IMU  | 0     | Normal or unused  |
| Arm IMU   | 1     | An IMU internal error occurred.   |
| Bucket IMU                                      | 2     | No data detected by IMU for five seconds.   |
| Body IMU  |       |   |
| Tilt bucket IMU                                 |       |   |
| Boom head pressure sensor                       | 0     | Normal or unused  |
| Boom bottom pressure sensor                     |       |   |

## ■ Error code list

For the errors of No. 1 to 10, only one item with the highest priority is displayed on the screen until the status is improved.

For the No. 11 and the subsequent errors, the error is issued as soon as it occurs.

| NO. | Error message                       | Content (outline)  | Cause → Action  |
|-----|-------------------------------------|--|---|
| 1   | No error                            | ---  |   |
| 2   | Unconnected to controller           | The information from the controller could not be acquired by the tablet.                         | <ul style="list-style-type: none"> <li>• Wi-Fi settings have not been configured.<br/>→ Check whether the connection destination is set to the controller in the Wi-Fi settings of the tablet.</li> <li>• The power to the controller is turned off.<br/>→ Check whether the LED lamp of the controller is lit.</li> </ul>  |
| 3   | No machine calibration              | The calibration information has a problem, and the cutting edge calculation cannot be performed. | When the value of the calibration information is incorrect<br>→ Check whether the calibration was performed correctly.  |
| 4   | Bucket is not selected              | Bucket file is not selected.   | Bucket file is not selected.<br>→ Check whether a bucket file is selected with the bucket settings.   |
| 5   | No correction data (VRS)            | The controller cannot acquire any correction data (VR).  | The tablet has not succeeded in connecting to the correction data distribution server.<br>→ Check the transmission/reception of correction data with the Ntrip settings on the tablet.  |
| 6   | No correction data (External radio) | The controller cannot acquire any correction data (external radio).                              | <ul style="list-style-type: none"> <li>• The fixed station is unable to send/receive correction data (external radio).<br/>→ Check the wireless transmission format of the fixed station and the type and number of captured satellites.</li> <li>• The controller is unable to receive correction data (external radio).<br/>→ Check the satellite type with the GNSS settings on the tablet.</li> </ul> |
| 7   | Project file is not selected        | Project file is not selected.  | Project file is not selected.<br>→ Check the completion of project file download and the project file selection.  |

| NO. | Error message         | Content (outline)  | Cause → Action   |
|-----|-----------------------|--|--|
| 8   | Localization error    | An error has occurred in the localization process.                 | <ul style="list-style-type: none"> <li>• Insufficient reference points for localization<br/>→ Check the reference points for localization.</li> <li>• Wrong coordinate type<br/>→ Check the coordinate type.</li> <li>• Too large residual (0.1 m or more)<br/>→ Check the residual.</li> <li>• Localization parameter calculation error<br/>→ Check the localization parameters.</li> </ul> |
| 9   | Projection error      | A calculation error has occurred in the projection process.        | Projection parameter setting error<br>→ Check the content selected for the projection.   |
| 10  | Out of design area    | No construction machine exists in the range of the design surface. | <ul style="list-style-type: none"> <li>• The cutting edge position of the construction machine exists outside the design surface.<br/>→ Check the design surface file and move the cutting edge position onto the design surface.</li> <li>• GNSS is not fixed.<br/>→ Check after the GNSS is fixed.</li> </ul>  |
| 11  | ○○ IMU Undetected     | ○○ IMU cannot be detected on the CAN signal.                       | <ul style="list-style-type: none"> <li>• ○○ IMU abnormality</li> <li>• Harness abnormality (e.g. wire breakage)<br/>→ Check the harness continuity. If there is no problem with the continuity of the harness, the IMU may have failed.</li> </ul>   |
| 12  | ○○ IMU Software error | ○○ IMU software error  | ○○ IMU abnormality<br>→ Cycle the power. → If the abnormality recurs after cycling the power, the IMU may have failed.   |
| 13  | ○○IMU Undetected      | ○○ IMU cannot be detected on the CAN signal.                       | <ul style="list-style-type: none"> <li>• ○○ IMU abnormality</li> <li>• Harness abnormality (e.g. wire breakage)<br/>→ Check the harness continuity. If there is no problem with the continuity of the harness, the IMU may have failed.</li> </ul>   |

| NO. | Error message             | Content (outline)                              | Cause → Action  |
|-----|---------------------------|--|---|
| 14  | ○○ IMU Software error     | ○○ IMU software error                          | ○○ IMU abnormality<br>→ Cycle the power. → If the abnormality recurs after cycling the power, the IMU may have failed.  |
| 15  | ○○ IMU Undetected         | ○○ IMU cannot be detected on the CAN signal.   | <ul style="list-style-type: none"> <li>• ○○ IMU abnormality</li> <li>• Harness abnormality (e.g. wire breakage)<br/>→ Check the harness continuity. If there is no problem with the continuity of the harness, the IMU may have failed.</li> </ul>            |
| 16  | GNSS antenna not detected | The controller cannot detect the GNSS antenna. | <ul style="list-style-type: none"> <li>• The antenna cable is broken or not connected.<br/>→ Check the antenna cable connection.</li> <li>• Antenna failure<br/>→ Replace the antenna.</li> <li>• Controller failure<br/>→ Replace the controller.</li> </ul> |

# 9. Contact information

---

■ **Inquiries about products:**

EARTHBRAIN Ltd.

Inquiry form page: <https://support.smartconstruction.com/hc/ja/requests/new>

Move to the inquiry form via the link.

■ **In case of troubles:**

Support Center

---

Smart Constriction 3D Machine Guidance Kit

---

Issued by: EARTHBRAIN Ltd.  
Izumi Garden Tower, 29th floor, 1-6-1  
Roppongi, Minato-ku, Tokyo

---

Copying and reprinting without permission is prohibited.



